



AMAZONE

Trailed sprayer **UG**



UG trailed sprayers

Modern and reliable!



The 2,200 and 3,000 litre UG trailed sprayer is characterised by its robust and operator-friendly design. With the Super-S2 boom in working widths from 15 to 28 m, the UG is an extremely high output sprayer.



UG

Successful in every field!

	Page
The advantages at a glance	4
Technology Chassis	6
Technology Steering	8
Technology Design and pumps	10
Technology Fresh water tank Induction bowl	12
Control AmaSpray ⁺ ProfiClick	14
Control ISOBUS	16
Control Comfort-Pack Boom Profile	24
Booms Super-S2	26
Booms Folding	28
Plant protection management	30
DUS Boundary nozzle switching	32
Additional equipment	34
Technical data	36

UG trailed sprayers

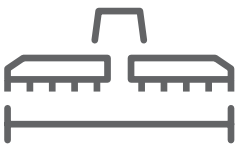

15 m – 28 m

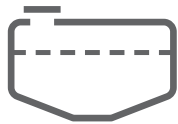

2,200 l – 3,000 l



up to 11
part-width sections



250 or 370 l/min
pump capacity

The advantages at a glance:

- ⊕ High ground clearance, with rounded frame
- ⊕ Robust construction but lightweight design
- ⊕ Lightweight spray liquid tank with favourable centre of gravity made from glass fibre reinforced plastic
- ⊕ Sprayer boom in superbly light, superbly strong and superbly compact profile construction
- ⊕ Outstanding boom suspension for a smooth boom ride
- ⊕ Efficient, maintenance-friendly, run-dry safe and self-priming piston diaphragm pump
- ⊕ Induction bowl with Power Injector, for quick, safe and accurate operation
- ⊕ Operator-friendly control valves

MORE INFORMATION

www.amazone.net/ug



DOWNLOAD
mySprayer-App



SMARTLEARNING
[www.amazone.net/
smartlearning](http://www.amazone.net/smartlearning)

Greater robustness for a greater output

Tough UG models

- ✔ UG 2200:
2,400 l actual volume with 280 l fresh water tank
- ✔ UG 3000:
3,200 l actual volume with 400 l fresh water tank
- ✔ Super-S2 boom:
15, 16, 18, 20, 21, 24, 25, 27 or 28 metres
- ✔ UG Special with a 250 l/min single pump
UG Super with 370 l/min dual pump



UG 2200 Special
21 m Super-S2 boom



Robust, stable and reliable

The wide, profile steel frame, compact tank and the robust boom technology all contribute to the required reliability. All the edges are rounded off and all hoses are neatly routed inside the frame.



Chassis of choice

The width adjustable axle can be specified unbraked or equipped with a dual-circuit compressed air, or hydraulic braking system, as required. The track width can be infinitely adjusted to between 1.50 and 2.25 m. 40 km/h type approval on request.

Soil structure and crop saving travel

Selection of the right tyres is of the utmost importance if the soil is to be protected during work.

AMAZONE mudguards can be adjusted for the various tyre options. The mudguard equipment option includes a large canister holder to the right hand side as standard.



For any linkage, the right drawbar

SelfTrail and UniTrail steering systems react directly to the steering action of the tractor. The following sprayer axle oversteers by a little when coming in into the turn. The tracking quality is completely independent from forward speed.



SelfTrail drawbar steering

A simple, sturdy drawbar is provided that gives continuous track following operation.

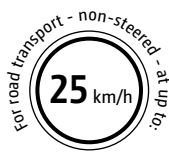

UniTrail drawbar steering

The UniTrail steering system can be quickly converted ready for road transport. In the transport position it is possible to drive safely at speeds of up to 40 km/h without a problem. Optionally, a hydraulic drawbar steering is available for when working across slopes.

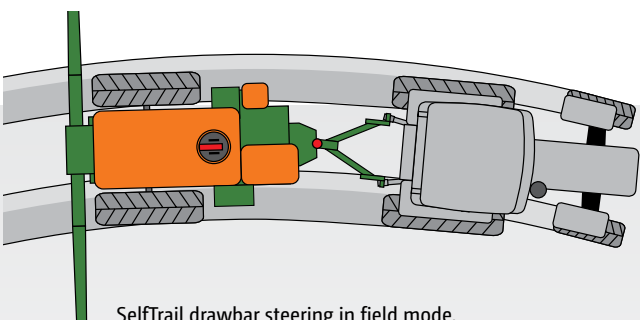

SelfTrail drawbar steering in field mode.

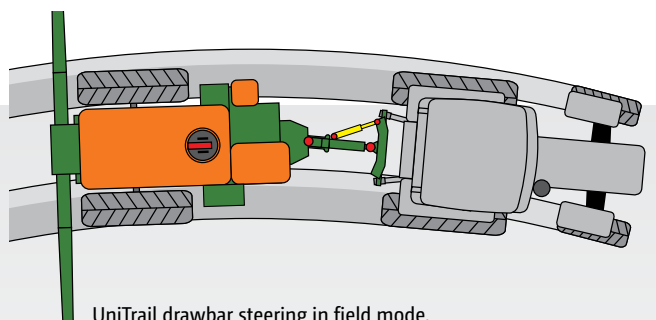

UniTrail drawbar steering in field mode.

Quick on the road – Excellent in the field!

AutoTrail steering systems are software-controlled and can be calibrated precisely to give near-perfect track following. In work, the steering system can either be manually overridden or switched off via the AmaPilot⁺ multi-function joystick.



Straight drawbar



Hitch drawbar

AutoTrail drawbar steering

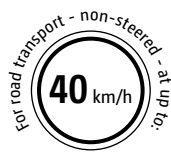

AutoTrail drawbar steering is available for both the straight drawbar and the hitch drawbar. A variety of towing eyes offer a solution to all tractor drawbar options.

As an alternative to the automatic slope correction adjustment with AutoTrail, there is on this drawbar also a manual hydraulic drawbar steering system for slope correction.

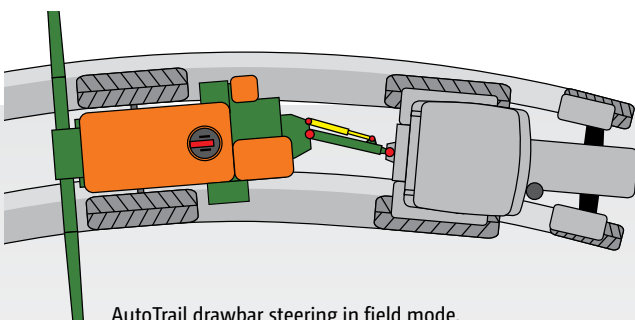

AutoTrail drawbar steering in field mode.

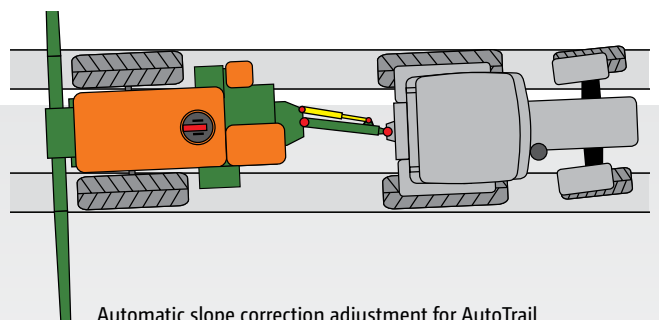

Automatic slope correction adjustment for AutoTrail

Proven technology for the most arduous of operations



- 1) Robust wide profile steel frame in which all hoses are routed so that they are protected.
- 2) Compact tank with smooth internal and external walls.
- 3) Induction bowl with Power-Injector for the induction of large quantities of chemicals and for canister flushing.
- 4) Large fresh water tank for diluting residual amounts or for cleaning the sprayer, even when the tank is full.
- 5) Separate hand wash tank (20 litres).
- 6) Mechanical direct fill level indicator with float and also electronically in the in-cab terminal as standard.
- 7) Clothing locker for agricultural protective clothing (optional).

✔ Clearly laid out operator station

All control elements are logically and unmistakably arranged directly to the front left-hand side of the sprayer. All the spraying functions can be quickly and intuitively understood thus preventing any operator errors.



The suction filter can be easily accessed via the simple AMAZONE bayonet coupling without the loss of spray liquid.

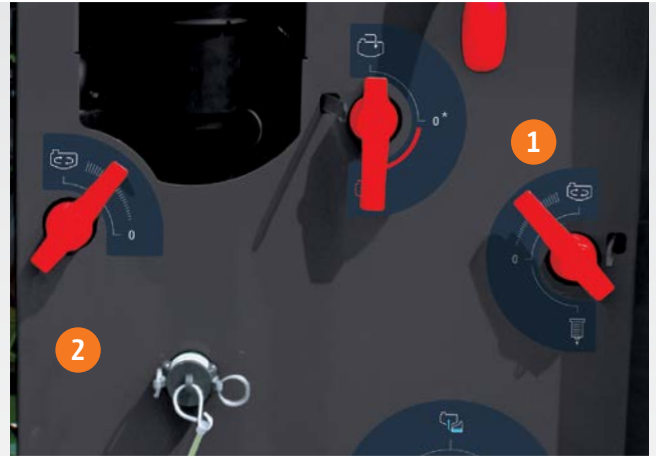

On AMAZONE sprayers, the flushing outflow from the self-cleaning pressure filter is used for agitation (switching via Pos. 1). The pump equipment on the UG Super is suitable for high agitation outputs at low PTO shaft speeds (switching via Pos. 2).

Piston diaphragm pumps

The piston diaphragm pumps are particularly reliable, protected when run dry and are safe for liquid fertiliser. The multiple-cylinder design of the pumps simultaneously ensures even delivery with a high suction power and smooth operation. The pumps are available with delivery capacities of 250 l/min (Special) or 370 l/min (Super). The 370 l/min pump setup is a tandem pump, where the spraying pump works together with a separate agitation pump. The tandem pump is ideal for farms using high application rates.



Hydraulic agitation intensity

The intensity of the hydraulic agitation can, steplessly, be reduced down to nothing in order to avoid any foaming of the crop protection agent or to facilitate spraying out the remaining tank contents.

On AMAZONE sprayers, the flushing outflow from the self-cleaning pressure filter is used for agitating (1). The pump equipment of the UG Super is suitable for high agitation outputs at low PTO shaft speeds (2).

Fill capacity 400 l/min

The sprayer can be filled with the help of a suction hose (3") with non-return valve or bowser fill connection with C-coupling. Utilising the additional injector that can be activated, means that filling rates of up to 400 l/minute can be achieved.



Filling via the suction hose



Filling using pressure (C or Camlok coupling)

AMAZONE application technology



🔒 Play it safe with the AMAZONE induction bowl.



Fresh water tank with Vario control for flushing and diluting

The large fresh water tank always carries sufficient clean water for flushing and for diluting residual quantities. If the Vario control is set to the “flush” position, the suction filter, pump, valve chest, boom spray line and nozzles are cleaned with fresh water.

This is also possible when the spray liquid tank is full. This rules out the possibility of malfunctions caused by dried on spray liquid.

Inducting via the induction bowl and power injector

The induction bowl is able to quickly and reliably dissolve powdered agents and large quantities of urea through the incorporated rinse ring and, at the same time, to quickly flush them in with the power injector.

A rotary nozzle ensures that the spraying agent canisters are easily and conveniently cleaned to make full use of the contents. The closed induction bowl can be flushed for self-cleaning. The fill level indicator is always in view.

Internal and external cleaning

Two powerful rotating nozzles clean the internal walls of the tank.

As an option, the outside of the boom can be cleaned in the field with the external wash kit. The spray lance with its 10 bar working pressure ensures a good cleaning effect.



AmaSpray⁺ in-cab terminal

AmaSpray⁺ – simple and versatile

The AmaSpray⁺ enables simple yet fully automatic control of the UG. Switches integrated into the operator terminal enable the control of 5, 7 or 9 part-width sections. The AmaSpray⁺ has a digital pressure display and a digital tank level indicator. It records the quantity applied and area worked. The hydraulic functions are operated using the spool valves on the tractor. The boom tilt and pendulum lock are also displayed in the AmaSpray⁺. As an option, AmaSpray⁺ enables one-sided folding of the boom or, alternatively, control of the end nozzles.

The AmaSpray⁺ operator terminal with serial Interface can also be used for automatic documentation (ASD) and part-area, site-specific application.

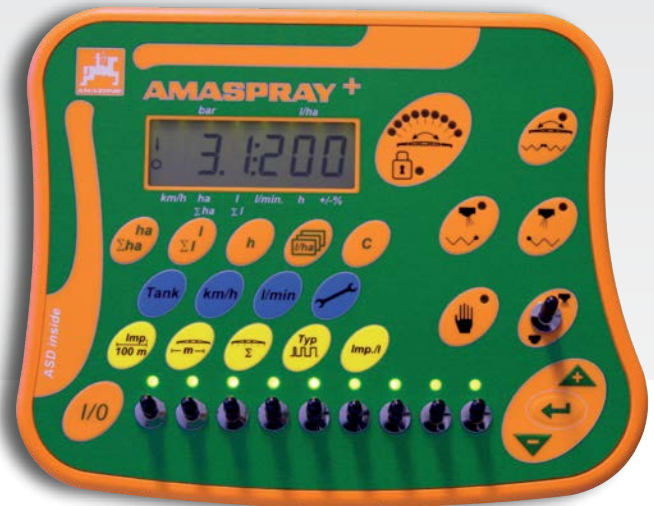

The benefits:

- ✔ Single, high-contrast, backlit screen
- ✔ Overall and part-width section control
- ✔ Up to 9 part-width sections
- ✔ Digital pressure indication
- ✔ Digital fill-level indicator
- ✔ Display of boom position and locking status
- ✔ Hectare meter (total and daily counter)
- ✔ +/- 10 % key
- ✔ Field record management system

Additional functions (with optional equipment):

- ✔ Pre-select fold for independent boom folding
- ✔ End or boundary nozzle on/off control (as an alternative to pre-select fold)
- ✔ Fold or tilt via 1 double acting spool valve (electric changeover switch)
- ✔ ASD inside: serial interface



Electrically-controlled TG valve chest

Cutting-edge valve technology is available for ISOBUS control and the AmaSpray⁺. The part-width boom sections are switched, on and off, quickly and drip-free via electric motor valves with pressure relief.

The amount applied is accurately and directly controlled by the computer in all situations. A unit with equal pressure compensation is not required with this system.

ProfiClick

The small switchbox with a huge comfort factor



✓ ProfiClick mounts conveniently on the AmaSpray+

For boom control and steering

The ProfiClick switchbox offers the simple and precise actuation of all hydraulic functions of the booms and steering with AMAZONE crop protection sprayers.

It is available in combination with the electro-hydraulic pack, "Profi-fold 1". All the operational functions of the ProfiClick switchbox are ergonomically arranged and directly linked with that function. The potentiometer for the re-adjustment of boom tilt or for the automatic steering of a trailed sprayer can be controlled on the move without looking thanks to the detent position in the centre. So the driver can concentrate perfectly on driving.

The ProfiClick control box for operating the hydraulic functions of an AMAZONE sprayer can be combined with the AmaSpray+ machine terminal or any ISOBUS terminal. Thus it offers a cost-effective and comfortable control of the hydraulic functions via an oil circuit. On the tractor, only one single acting spool valve with a pressure-free return flow is required.



✓ ProfiClick switchbox without steering
– Actuation of the boom functions via the oil circuit



✓ ProfiClick switchbox with steering
– Actuation of the boom functions and the steering for true track following via the oil circuit

- ① Ergonomic hand support
- ② On/off
- ③ Boom pendulum lock
- ④ Boom fold
- ⑤ Boom up/down
- ⑥ Boom tilt

- ① Ergonomic hand support
- ② On/off
- ③ Steering in automatic/manual
- ④ Manual steering
- ⑤ Boom pendulum lock
- ⑥ Boom fold
- ⑦ Boom up/down
- ⑧ Boom tilt

MEMBER OF



ISOBUS as the basis for intelligent communication

One language, many benefits!

Each ISOBUS-enabled machine from AMAZONE comes with the latest technology and almost unlimited possibilities. It makes no difference whether you use an operator terminal from AMAZONE or an ISOBUS terminal fitted directly in the tractor. ISOBUS is an internationally recognised standard for communication between the operator terminal, tractors and connected implements on the one hand and Farm Management Information Systems on the other.

Operation with a wide variety of ISOBUS terminals

Which means that ISOBUS enables you to take control of all your ISOBUS compatible equipment. You only have to connect the machine to the respective ISOBUS terminal and the usual operator interface appears on the monitor in your tractor cab.

Benefits of ISOBUS at a glance:

- ✔ This worldwide standard provides a uniform interface and data exchange format that ensures compatibility even with third party manufacturers
- ✔ Plug and Play between machine, tractor and additional ISOBUS implements





Perfectly developed machine operation from AMAZONE

AMAZONE machinery and operator terminals offer a range of functions which are very easy and safe to operate:

- ✔ Highest compatibility and function flexibility of your ISOBUS equipment
- ✔ No additional modules on the machine side. All ISOBUS machines from AMAZONE come ready-equipped with the necessary ISOBUS functions as standard
- ✔ Practice-oriented machine software and logical menu structure
- ✔ MiniView display with all AMAZONE terminals and additional ISOBUS terminals. See, for instance, the machine data in the map view.
- ✔ Possibility of operating the machine via the tractor terminal or a twin terminal solution
- ✔ Flexible assignment of the map and machine view between the tractor terminal and the operator terminal
- ✔ Unique operating concept. Freely configurable displays and individual user interfaces for each driver
- ✔ Useful additional functions such as automatic boom lowering on AMAZONE crop protection sprayers
- ✔ Integrated TaskController data logger function



Clearly-structured AMAZONE machine operation

Advantages of the AMAZONE machine software:

- ✔ User-oriented and intuitive
- ✔ Tailored to the machine
- ✔ Function scope above and beyond the ISOBUS standard

Clear display of the work menu in the AMAZONE machine operation



Automatic part-width section control GPS-Switch with Section Control

Example: 24 m boom width (6-6-8-8-8-6-6 = 48 nozzles)

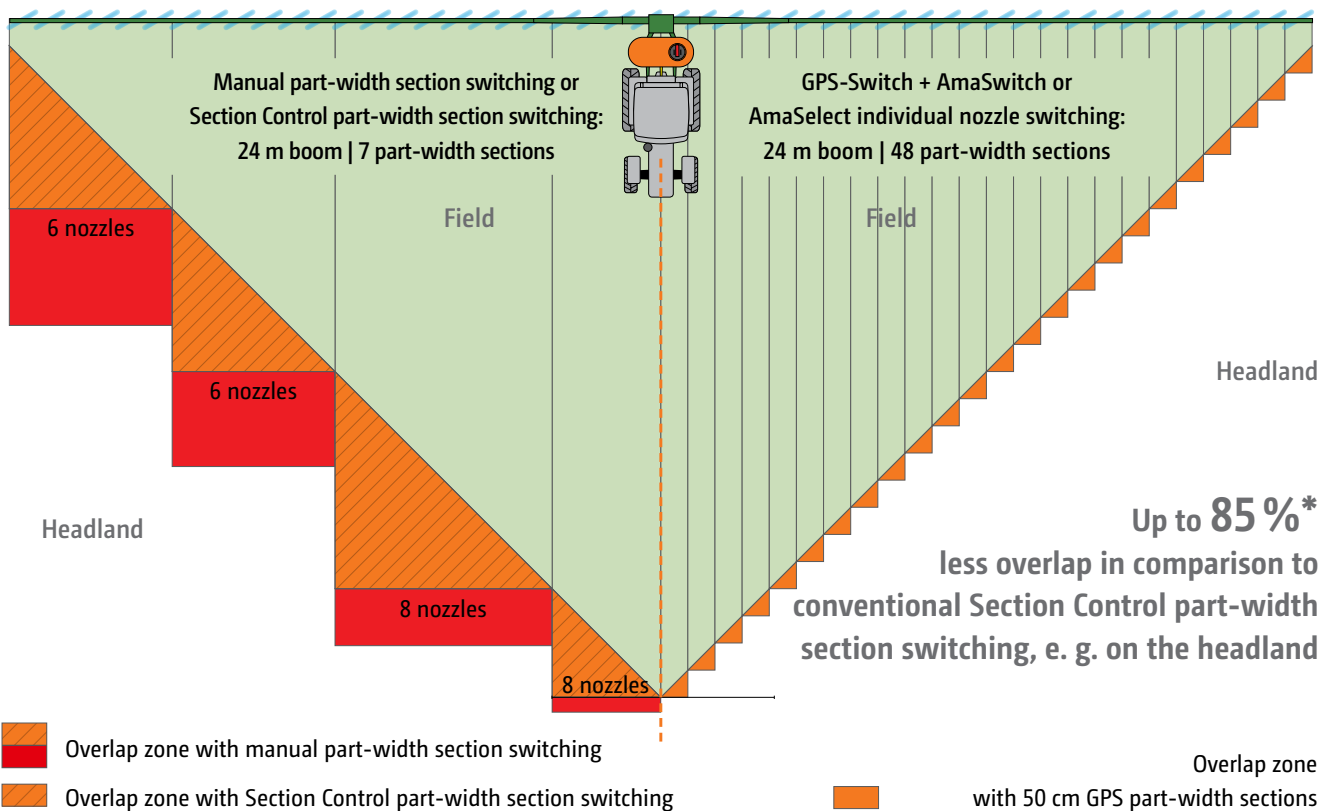

Automatic part-width shut-off for the headland and wedge-shaped fields **GPS-Switch**

5%*

Saving on crop protection agent usage



Electric individual nozzle switching **AmaSwitch or AmaSelect**

5%*

Additional saving on crop protection agent usage

* Savings are dependent on field shape, boom width and the number of part-width sections

Precise switching in 50 cm part-width sections

The decisive benefit of the individual nozzle control is the possibility to operate with small part-width sections giving an even greater degree of precision in wedge shaped fields, short work and on the headland. If AmaSwitch or AmaSelect is combined with the automatic GPS-Switch Section Control, the automatic switching of individual nozzles in 50 cm part-width sections is made possible. With this system, areas of

overlap are significantly reduced and are, in comparison with a conventional Section Control part-width section shut-off system, up to 85 % less. So, the combination of GPS-Switch and individual nozzle control results in, depending on field shape and size, the working width and number of part-width sections, significant savings of spray agent compared with a normal spraying system used thus far.

Overlaps on the headland or in wedge shaped fields are prevented via precise switching with GPS-Switch.



If the operating terminal facilitates Section Control, such as GPS-Switch part-width section control from AMAZONE, the part-width sections are activated completely automatically and in relation to the GPS position. Once a field has been created, and once in automatic mode, the driver can concentrate fully on the operation of the towing vehicle, since the part-width sections are switched automatically in wedge shaped fields and on headlands.

Benefits of automatic part-width section control:

- ✔ Stress relief for the driver
- ✔ Increase in precision, especially at night or at higher speeds
- ✔ Less overlaps and gaps
- ✔ Saving inputs
- ✔ Less crop damage and environmental impact
- ❗ “With Section Control, the ISOBUS terminal takes on so much of the work from the driver.”
 (“dlz agrar magazine” – test report ZA-TS fertiliser spreader · 02/2017)

GPS-Switch

With GPS-Switch, AMAZONE offers GPS-based, fully automatic, part-width section control for all AMAZONE operator terminals and ISOBUS-compatible fertiliser spreaders, crop protection sprayers or seed drills.

GPS-Switch basic

- ✔ Automatic part-width section control with up to 16 part-width sections
- ✔ Creation of a virtual headland
- ✔ Automated boom lowering with an AMAZONE crop protection sprayer
- ✔ Optional with AmaTron 4

GPS-Switch pro (as an add-on to GPS-Switch basic)

- ✔ Automatic part-width section control with up to 128 part-width sections, particularly for crop protection sprayers with individual nozzle control
- ✔ Marking of obstacles (e.g. water holes, pylons)
- ✔ Auto-zoom when approaching the headland
- ✔ Optional with AmaTron 4

✔ AmaClick

Special crops and bed work often require the on/off switching of the individual part-width sections in the middle of the boom. AmaClick is an additional ergonomic control unit that can be used either in conjunction with the AmaPilot⁺ multi-function joystick or also as a standalone system alongside an ISOBUS terminal.



Workday made easy –

Make the most of the possibilities!

GPS-Maps&Doc

All standard ISOBUS terminals from AMAZONE can collect and save machine and site-specific data using Task Controller. Part-area, site-specific operation via application maps in either Shape file or ISO-XML formats is also possible.

- ✔ Easy creation, loading and processing of jobs
- ✔ Start a new task straight away and decide later whether the data is to be saved or not
- ✔ Import and export jobs in ISO-XML format
- ✔ Job summary via PDF export
- ✔ Intuitive system for processing application maps in either Shape file format and ISO-XML format
- ✔ Automatic part-area, site specific regulation of the application rate
- ✔ Indication of inactive field boundaries and automatic field detection when approaching the vicinity
- ✔ Optimum crop management via needs-based application
- ✔ Available as standard with AmaTron 4

GPS-Track

The GPS-Track parallel guidance greatly helps with orientation in the field, especially on grassland or in areas without tramlines.

- ✔ With a virtual light bar in the status bar
- ✔ Automatic tramline control via GPS for seed drills
- ✔ Various track modes such as A-B lines or contour following
- ✔ Optional with AmaTron 4

AmaCam

Software licence for displaying a camera image on AmaTron 4.

- ✔ Automatic display of the camera image on AmaTron 4 when reversing



Display of the application map in AmaTron 4



Display of the camera image in AmaTron 4

AmaTron 4

Manager 4 all



Simple and convenient operation as intuitive as your tablet

Why not handle a terminal as intuitively as a tablet or a smartphone? With this in mind, AMAZONE has developed the operator-friendly AmaTron 4 which offers a noticeably smoother operational procedure, especially when it comes to job management. The AmaTron 4, with its 8" multi-touch colour display meets the highest expectations and offers maximum user-friendliness. A swipe of the finger or use of the App carousel allows quick changes between applications and the simple and clearly structured operating menu. A useful MiniView, a freely configurable status bar as well as a virtual light bar make the use of the AmaTron 4 particularly clear and convenient.

Benefits of AmaTron 4:

- ✔ Automatic full screen mode when not being touched
- ✔ Automatic display of the touch buttons via a proximity sensor
- ✔ Practical MiniView concept
- ✔ Actuation via the multi-touch colour display or soft keys
- ✔ Particularly intuitive and user-friendly
- ✔ Field-related documentation
- ✔ Practice-oriented and intelligent menu navigation
- ✔ Practical quick-start menu with import and export of job data, help windows, day/night mode and the AUX-N assignment
- ✔ One camera input and automatic reversing detection
- ✔ Free trial period for all chargeable licences
- ✔ AmaTron Connect – for the optional entry into the digital age

Equipped as standard with:

GPS-Maps&Doc



AmaPilot⁺ – everything in the one hand!

Thanks to the AUX-N feature, you can operate multiple functions on the machine via AmaPilot⁺ or any other ISOBUS multi-function joysticks.

Advantages of AmaPilot⁺:

- ✔ Nearly every function is controlled directly via the 3 levels
- ✔ Adjustable palm rest
- ✔ Freely-programmable, individual key layout

AmaTron Connect

New ways of comfortable networked operation

With AmaTron Connect, AMAZONE provides a digital interface to a smartphone or tablet. The mobile device and AmaTron 4 are simply connected as a hotspot. AmaTron Connect enables use of the AmaTron Twin App as well as data exchange via agrirouter and the myAmaRouter App.

AmaTron Twin App Clear display enhancement

The AmaTron Twin App offers the driver even more comfort during work, as any GPS functions in the map view can also be operated via a mobile device, e.g. a tablet, in parallel with machine operation on the AmaTron 4.

Now download the free App and try the DEMO in the App.

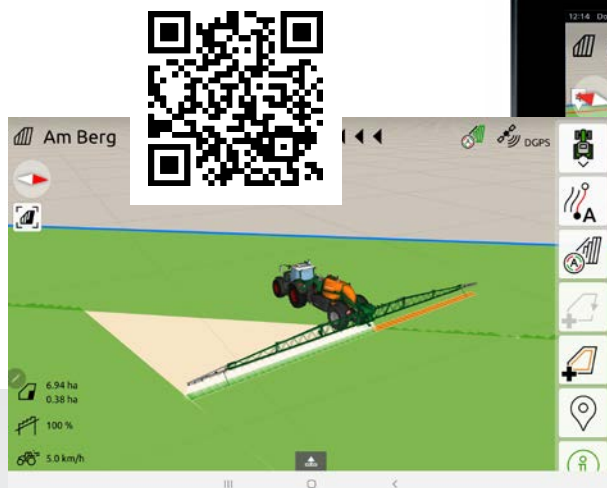

Everything in view at all times with the AmaTron Twin App and the holder kit for a tablet for rigid mounting on the AmaTron 4

Advantages of the AmaTron Twin display enhancement:

- ✔ Use of an existing mobile device
- ✔ Greater clarity – all applications in sight
- ✔ Comfortable control of the GPS functions in the map view, in parallel, via the mobile device
- ✔ Clear, authentic representation of the working machine and its part-width sections

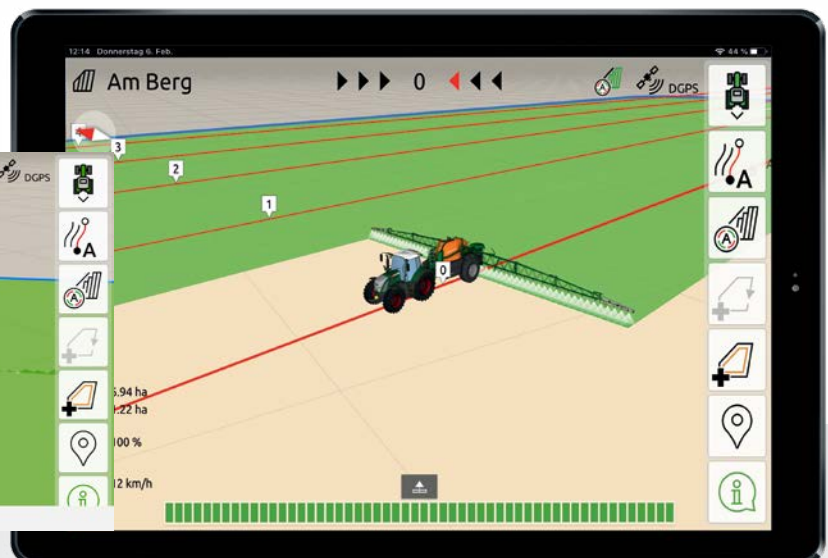

Alternative map views with AmaTron Twin – clear display of the machine and its part-width sections, as well as buttons on the right hand side of the mobile device.

agrirouter –

the independent data exchange platform for agriculture



Watch the video for more details

Secure data exchange

agrirouter is an independent data exchange platform for farmers and contractors. It enables simple and cross-manufacturer data exchange between machines and agricultural software applications, thereby reducing administration. The user retains full control over the data at all times.

myAmaRouter App

For the on-line transfer of data between AmaTron 4 and agrirouter

The myAmaRouter App enables data to be exchanged between the AmaTron 4 ISOBUS operator terminal and the agrirouter manufacturer-independent data exchange platform. If an AMAZONE machine is to be used to carry out a task with job data (e.g. application maps), the data can be easily transmitted from a Farm Management Information System (FMIS) to AmaTron 4 via agrirouter and the myAmaRouter App. After the work has been completed, the job can be sent back and is available for documentation in an agricultural software application.

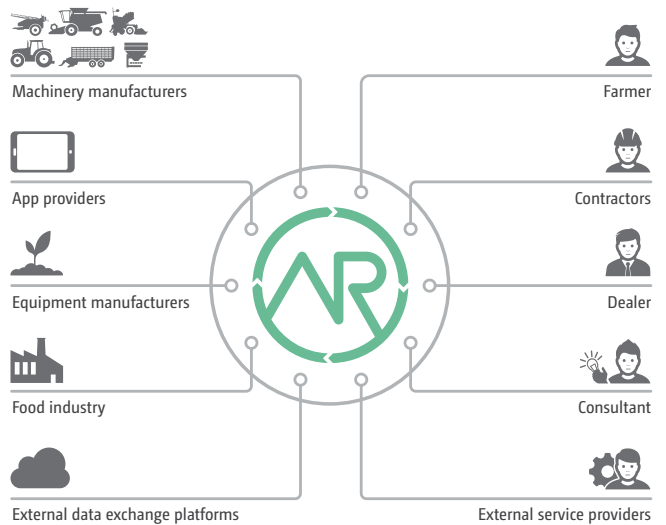

The manufacturer-independent agrirouter enables secure and uncomplicated data exchange.

Benefits of agrirouter:

- ✔ Simple data exchange between the AmaTron 4 ISOBUS operator terminal and the manufacturer-independent agrirouter data exchange platform
- ✔ Easy and rapid transfer of job and task data without the need for a USB stick
- ✔ More flexibility in data exchange and documentation

Uncomplicated data transfer. Transparent and secure!



Comfort-Pack for ISOBUS terminals

Operator- and environmentally-friendly



Comfort-Pack

Control of the spray liquid system

The AMAZONE Comfort-Pack controls the most important functions of the liquid system.

- ✔ Automatic fill stop
- ✔ Agitator regulation
- ✔ Automatic, in-cab remote cleaning

The intensity of the hydraulic agitator is, depending on the fill level, reduced until completely shut off to prevent foaming of the crop protection agent or to minimise the residual spray volumes. On AMAZONE crop protection sprayers the un-sprayed plant protection agent is delivered back via the return flow into the suction system. In this way, any unintended dilution of the spray liquid is prevented. 370 l/min

agitation capacity is available to achieve a perfect result even with difficult tank mixes and high concentrations. The 2 interior cleaning nozzles provide an optimum cleaning performance in the tank. The Comfort-Pack automatically ensures that the agitation will be rinsed.

Minute final residual volumes of less than 6 litres and the large fresh water contents ensure a very effective cleaning procedure whilst still in the field.

AMAZONE aircraft-style boom design

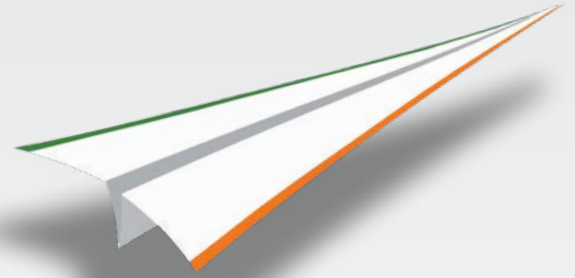

Simultaneously superbly strong and superbly light

Due to the special profile design AMAZONE sprayer booms are very light yet at the same time very robust. Working widths of 15 to 28 metres allow optimum adaptation to the field sizes and topography on the farm with various folding options. The exceptionally high-quality ensures a long operational life even over very high acreages.



Superbly narrow transport width of only 2.40 m

The Super-S2 boom folds fully automatically in and out via hydraulic rams. In the transport position, the boom sits compactly behind the tank with a transport width of only

2.40 m and a transport height of 3.30 m. With steel profiles up to 140 mm wide with multiple bends, the Super-S2 boom is extremely strong.



Super-S2 boom: firm and steady



3-fold shock damping suspension for the most difficult operating conditions

As standard all AMAZONE booms are equipped with

- ✔ springs and shock absorber pack for damping the vertical roll movements,
- ✔ rubber buffer damping elements with ball suspension to damp down the horizontal yaw movements and
- ✔ tension springs for the shock absorbed suspension of the entire boom.

As standard also is hydraulic height adjustment with guide skids that results in the perfect boom guidance and thus, the accurate longitudinal and lateral distribution of the spray liquid.

Super-S2 boom suspension

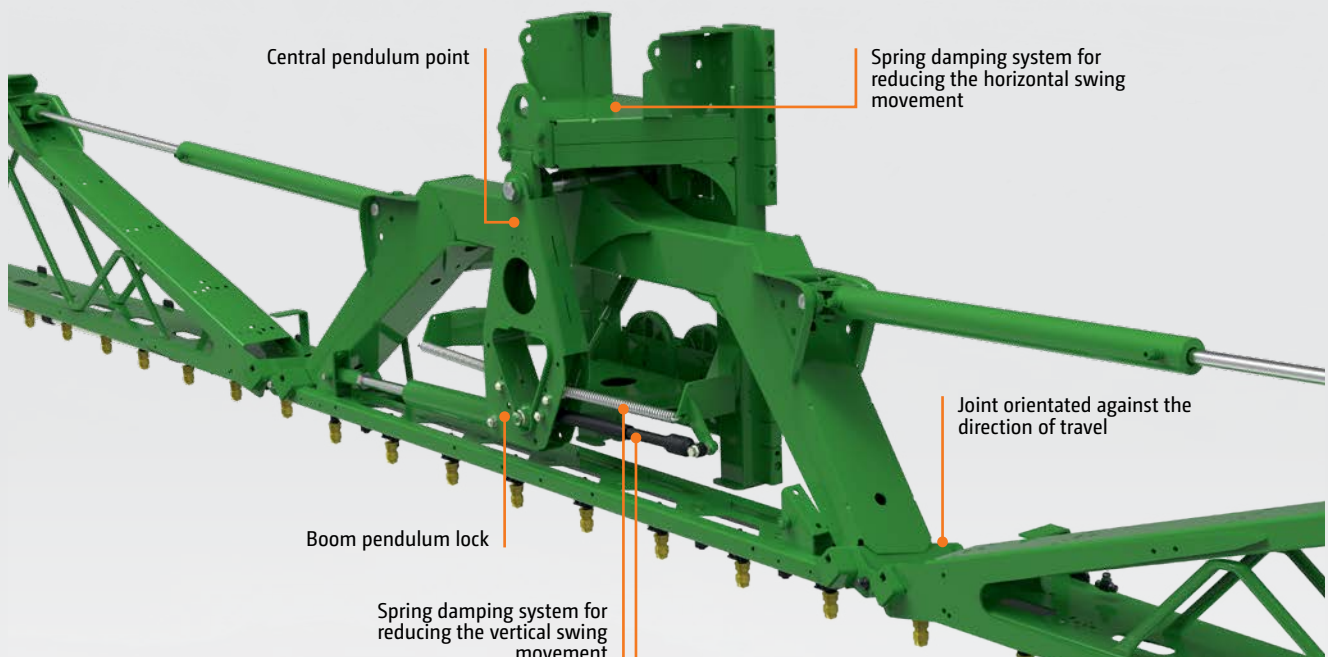

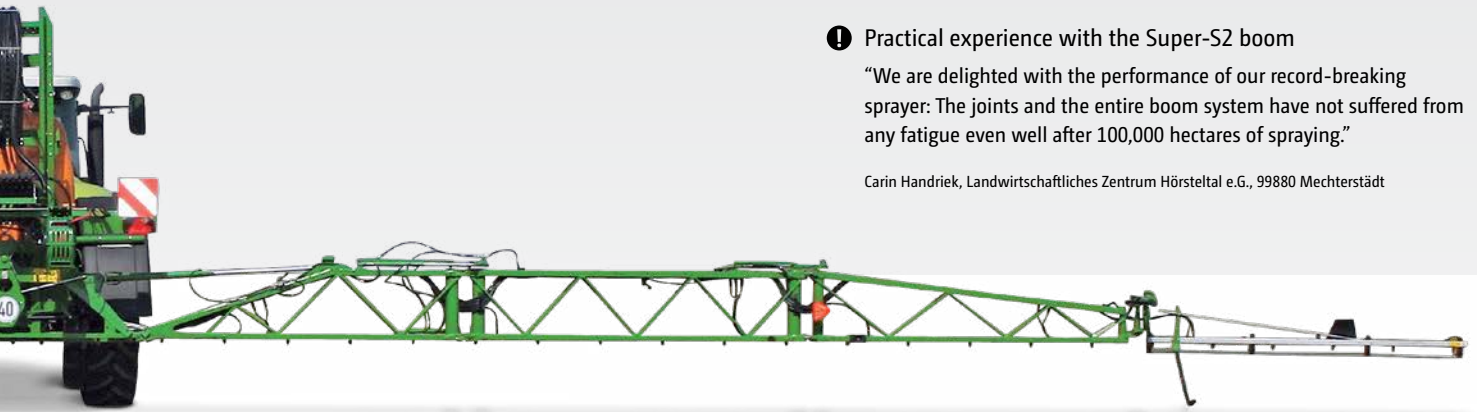

📌 Practical experience with the Super-S2 boom

“We are delighted with the performance of our record-breaking sprayer: The joints and the entire boom system have not suffered from any fatigue even well after 100,000 hectares of spraying.”

Carin Handriek, Landwirtschaftliches Zentrum Hörstetal e.G., 99880 Mechterstädt

Maintenance-free and with a long service life

The decades of experience in boom design pay off: The conical hinge pin is the intelligent centre of a well thought-out boom philosophy! The boom pivots self-adjust against any play on the conical hinge pins and that ensures, for the end user, an optimised boom function even after many years.

The standard use of stainless steel, the automotive-industry standard, cathodic dip painting process and the targeted use of plastics and aluminium are the perfect guarantee of a long service life.

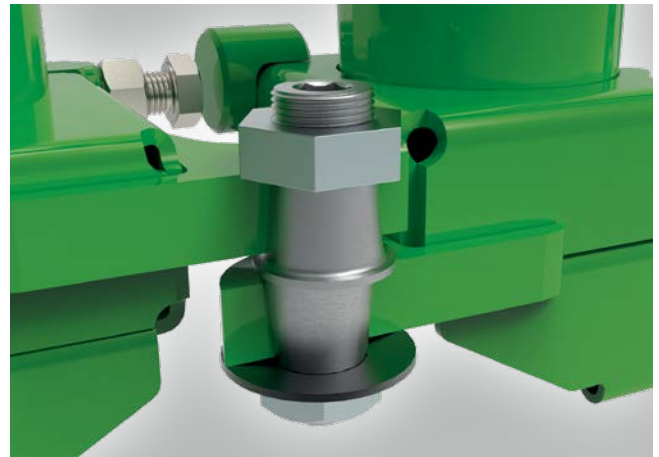

📌 A pivot joint that lasts!

Boom layout and folding variants of the Super-S2 boom

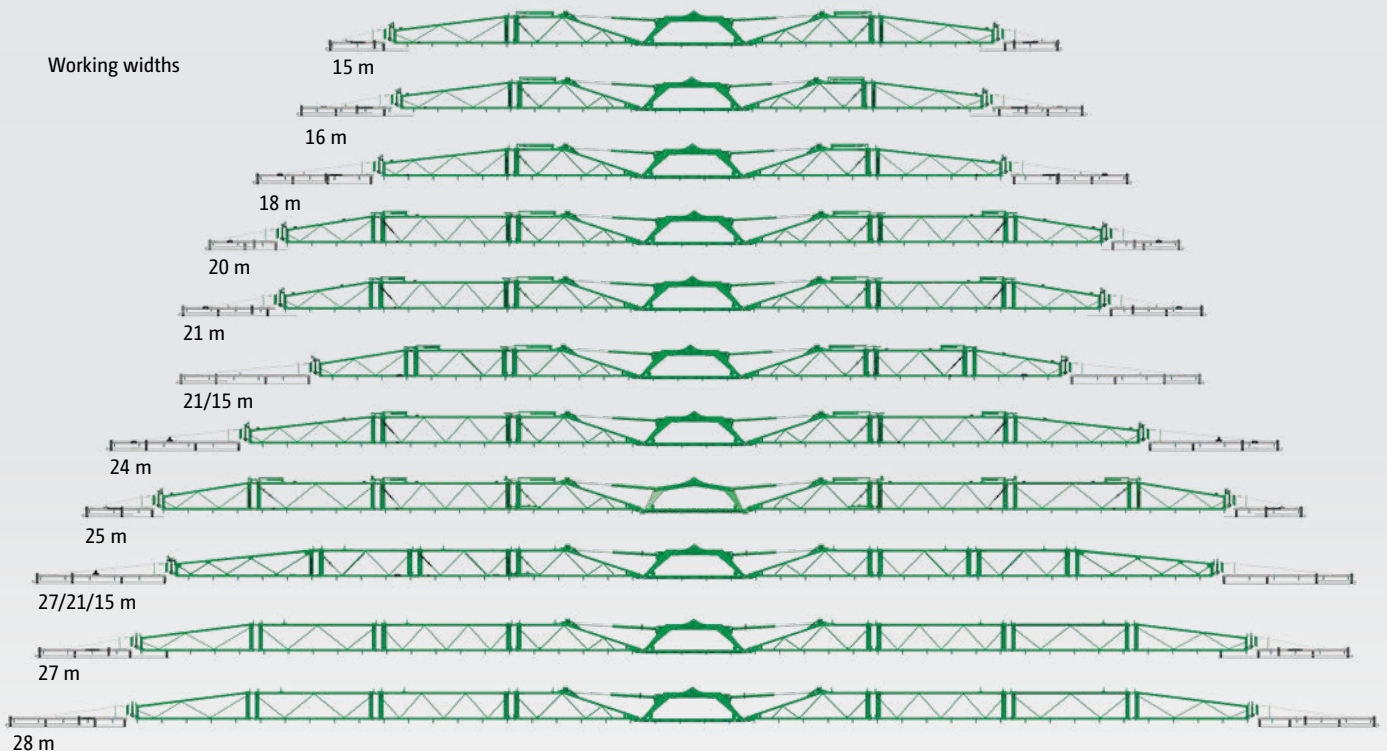

Flexibility thanks to the hydraulic boom folding permutations



✔ Standard folding

All boom options are folded fully hydraulically by oversized hydraulic cylinders.

✔ Hydraulic tilt adjustment

On sloping terrain and with large working widths, the additional hydraulic tilt adjustment with its in-cab tilt display is useful.

Pre-select folding

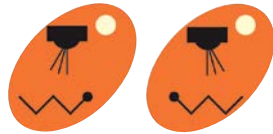

One-side folding via tractor spool valves is possible with the AmaSpray⁺ or an ISOBUS terminal.

The high level of flexibility offered by the pre-select folding function enables all boom sections to be folded individually. Both the left and right-hand sides can be folded in sepa-

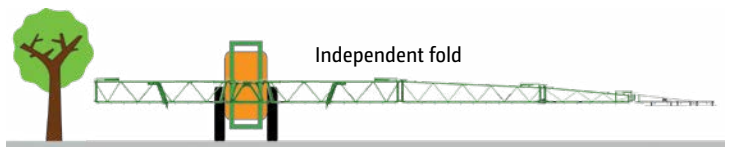

ately and independently of each other in order to adapt to any circumstances in your fields.

Profi-fold

Profi-fold refers to the electro-hydraulic actuation of the boom via an oil circuit. Height adjustment, folding in and out, independent folding, boom width reduction and tilt adjustment functions (Profi-fold 1) can be

easily controlled via the ISOBUS terminal or the multi-function joystick. Additional boom tip angling is possible with Profi-fold 2.

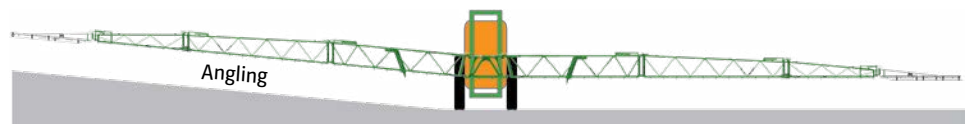

Profi-fold 2

DistanceControl with 2 sensors or DistanceControl plus with 4 sensors

The DistanceControl fully automated boom guidance system with 2 sensors, or DistanceControl plus with 4 sensors, is possible on all boom variants in conjunction with Profi-fold 1 or Profi-fold 2. In heavily differing crop heights, or in areas with partially lodged corn, it could be that the boom, when equipped with 2 sensors, dips into the crop. In this

case, equipping the boom with four sensors will prevent this. The sensors are electrically connected in parallel and so it is always the sensor that is closest to the target surface that is actuated.

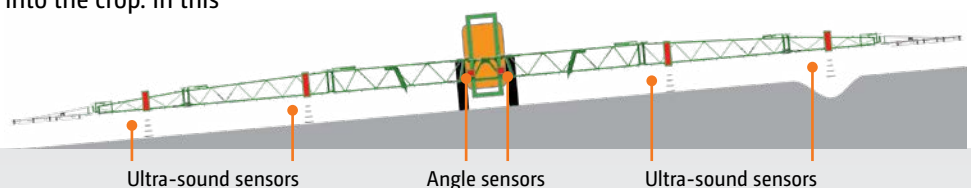

The right nozzle choice

The basis for success in crop protection



Less drift also at higher wind speeds

With the air-assisted injector nozzles, crop protection agents can be applied with very little drift. They are universally usable in all crops and all classifications. Because of the coarse droplet application, these nozzles can also be used in higher wind speeds.

AMAZONE offers a wide range of nozzles from agrotop, Lechler and TeeJet.

Single and multi-nozzle bodies

The nozzle bodies with integrated diaphragm non-return anti-drip valves fit up into the boom profiles reliably preventing any dripping at the nozzle. Self-adjusting bayonet fixings ensure a tool-less quick nozzle change. The 3-fold or 4-fold nozzle bodies are suited to frequent nozzle changes due to different applications and crops. Nozzle protection tubes, as standard on the outer sections, or, if desired, over the entire boom working width, ensures protection for long injector nozzles and multiple nozzle bodies.





Examples

- 1) Lechler IDN 120-025
- 2) TeeJet XRC 110-025
- 3) Injector flat fan nozzle AirMix 110-04



Everyone purchasing an AMAZONE crop protection sprayer receives, free of charge, an AMAZONE nozzle mounting tool that enables a much easier nozzle change.

Injector nozzles (ID, TTI) have a relatively coarse droplet spectrum and are particularly versatile with regard to their field of application. A pressure range of 2 to 8 bar is possible.

The split spray pattern ensures a more even deposit on the front and back of the plant and makes sense maybe, for example, in ear treatment.

If coverage quality is at the foreground of the application, the use of standard or anti-drift fine droplet nozzles, such as XR or AD, is recommended. Special care is required here due to their tendency to drift above 3 bar.

For speeds greater than 10 km/h, the TD HiSpeed nozzle with its asymmetrical spraying angle is becoming a new industry trend.

A good compromise is provided by the modern ID-K or Airmix compact injector nozzles. These have relatively little drift, but do not have too coarse a droplet spectrum and are operated at 2 to 4 bar.

Distribution of the droplet size

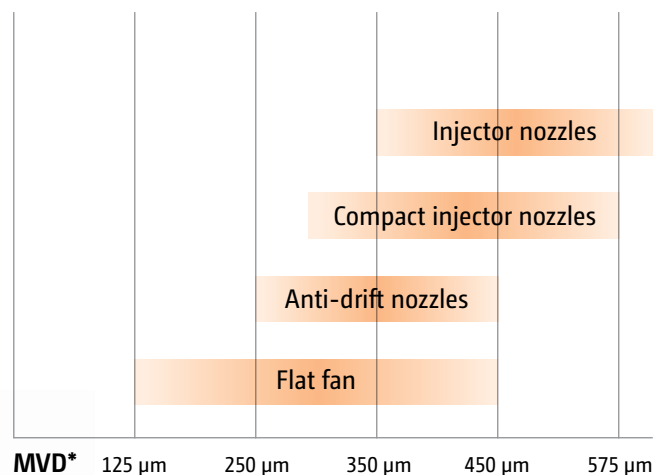

When it comes to special coverage qualities, the double flat fan nozzle is an interesting alternative: the AVI Twin from Agrotop also produces droplets that are not too fine.

MVD* 125 µm 250 µm 350 µm 450 µm 575 µm
 very fine droplet fine droplet medium droplet extremely coarse droplet coarse droplet very coarse droplet

* mean volumetric diameter



DUS pressure recirculation system

With DUS you determine the timing

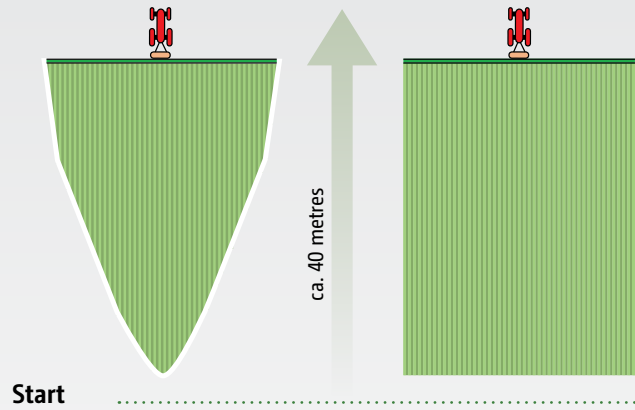

without DUS

with DUS Immediate coverage over the full working width

The DUS pressure recirculation system – proven more than 10,000 times

The AMAZONE DUS pressure recirculation system ensures a reliable circulation throughout the entire system. When starting the spraying operation, all the hoses including the spray lines are filled under pressure in the reverse direction with the mixed spray agent. This means the spray lines are always full and immediately ready to use over the entire working width. There is no waiting on the headland.

Every time individual part-width sections are shut off, during the turning operation and during transport, the spray liquid circulates continually thanks to the pressure recirculation system. This reliably prevents deposits, blockages or segregation in the spray lines.

During the cleaning operation, fresh water flushes the spray lines out right up to the nozzles without any spraying being necessary. During this cleaning procedure, the concentrated spray liquid is returned back to tank via the pressure recirculation system leaving the spray lines clean.

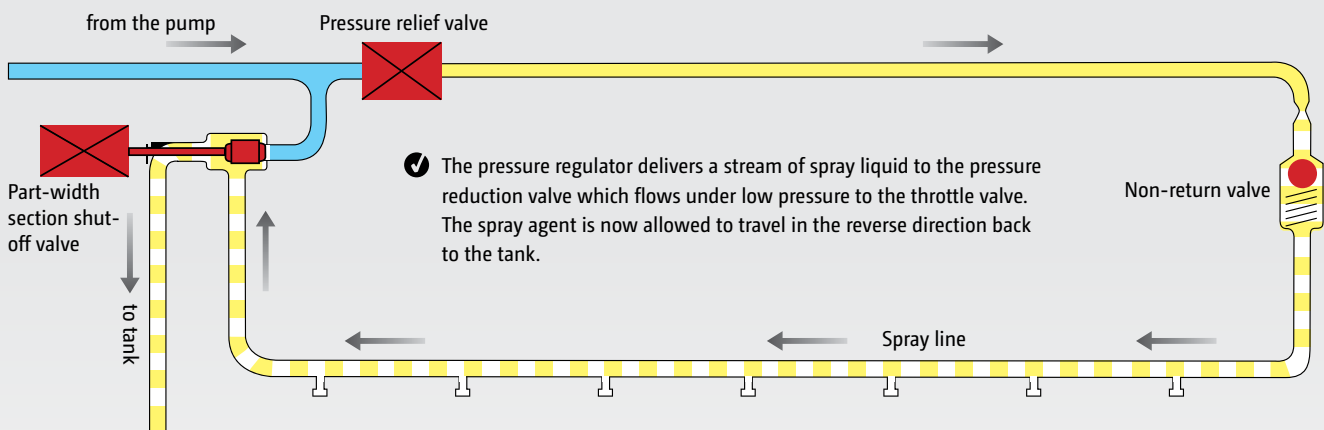

Electric boundary nozzle switching

For environmentally-friendly spray application at the field edge

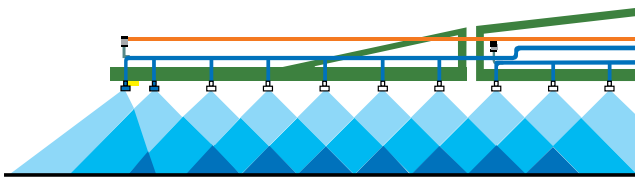

Additional nozzle switching

In order to extend the normal working width, an asymmetrical nozzle can also be switched on. This is particularly useful if the distances between tramlines are not precise enough.

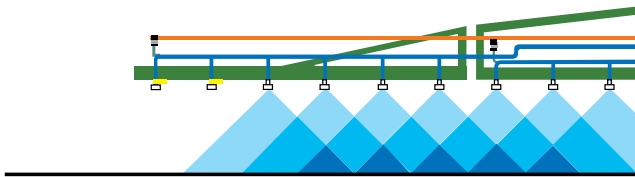

End nozzle switching

If a one metre buffer zone around the edge of the field needs to remain unsprayed due to distance constraints, end nozzle switching can be used.

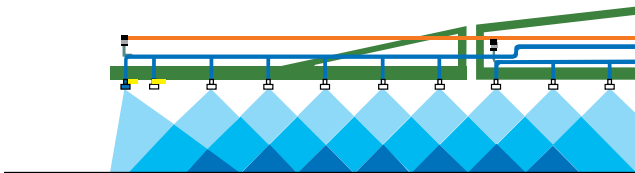

Boundary nozzle switching

For precision border spraying between two sensitive crops, the boundary nozzles can be used to make sure the spray pattern is accurately defined.



Equipment for every requirement



Drag hose with articulated joint

Liquid fertilising – Safe and user-friendly

For coarse droplet distribution of liquid fertiliser, AMAZONE offers a variety of special nozzles.

In conjunction with the Super-S2 boom, separate drag hose equipment for risk-free, late fertilising is available. The self-contained aluminium profiles can be attached with a few hand clamps. Drag hoses offer a risk-free late top dressing with liquid fertiliser and stainless steel weights help keep the position of the drag hoses within the crop.



7-hole nozzle



Camera system to the rear of the UG trailed sprayer

The optionally available camera system mainly serves for safety when manoeuvring. This is ensured even in rain, twilight or in darkness via infrared LEDs and a heated lens. The high resolution, antiglare monitor is backlit and can also display two cameras at once.



LED boom lighting for Super-S2 booms

For flexible and efficient operation at twilight and in the dark, LED boom lighting is available.

Two far-reaching LED work lights, mounted in the middle of the boom, ensure excellent visibility of all the nozzles at a glance.

LED individual nozzle lighting for Super-S2 booms

Professional work lighting is today the basis of a flexible, output-increasing solution to operating in twilight and at night. Illumination of the spray fans ensures complete control of the nozzle function at just one glance.

LED individual nozzle lighting picks out each individual spray fan. An absolutely immediate assessment of their operation down to the very last nozzle on the boom can be made.



Technical data: UG Special and UG Super

Model	UG 2200 Special	UG 2200 Super	UG 3000 Special	UG 3000 Super
Actual volume (l)	2,400		3,200	
Fresh water rinse tank (l)	280		400	
Working width (m)	15 – 28			
Transport height (m)	3.30			
Transport length (m)	5.20 – 5.90			
Transport width (m)	2.40			
Empty weight with Super-S2 boom (kg)	2,350 – 2,582	2,461 – 2,693	2,573 – 2,805	2,685 – 2,917
Pump equipment (l/min)	250	370	250	370
Max. suction capacity (l/min)	400			
Ground clearance	for every drawbar and tyre size 0.70 – 0.90 m			
Spraying height	0.50 – 2.20 m (with tyres Ø 1,565 mm)			
Operating pressure, max. (bar)	< 10			

Illustrations, content and technical data are not binding! Deviations of technical data are possible depending on the equipment. The illustrations may deviate from the requirements for local road traffic regulations.

