



AMAZONE

Trailed sprayer **UG**



UG trailed sprayers

Modern and reliable!



SPEED
spraying

The 2,200 and 3,000 litre UG trailed sprayer is characterised by its robust and operator-friendly design. With the Super-S2 boom in working widths from 15 to 28 m, the UG is an extremely high output sprayer.



UG

Successful in every field!

	Page
The advantages at a glance	4
Technology Chassis	6
Technology Steering	8
Technology Design and pumps	10
Technology Fresh water tank Induction bowl	12
Control AmaSpray ⁺ ProfiClick	14
Control ISOBUS	16
Control Comfort-Pack Boom Profile	26
Booms Super-S2	28
Booms Folding	30
Plant protection management	32
DUS Boundary nozzle switching	34
Additional equipment	36
AMAZONE Service	38
Technical data	40

UG

The 100,000 ha trailed sprayer

Spray liquid tank with

2,200 or 3,000 litres

Super-S2

sprayer boom in a
lightweight design



Boom widths of

15 to 28 m



The advantages at a glance:

- ⊕ High ground clearance, with rounded frame
- ⊕ Robust construction but lightweight design
- ⊕ Lightweight spray liquid tank with favourable centre of gravity made from glass fibre reinforced plastic
- ⊕ Sprayer boom in superbly light, superbly strong and superbly compact profile construction
- ⊕ Outstanding boom suspension for a smooth boom ride
- ⊕ Efficient, maintenance-friendly, run-dry safe and self-priming piston diaphragm pump
- ⊕ Induction bowl with Power Injector, for quick, safe and accurate operation
- ⊕ Operator-friendly control valves

State-of-the-art **ISOBUS**
communication



UG 3000 Super
24 m Super-S2 boom



MORE INFORMATION
www.amazone.net/ug

Greater robustness for a greater output

Tough UG models

- ✔ UG 2200:
2,400 l actual volume with 280 l fresh water tank
- ✔ UG 3000:
3,200 l actual volume with 400 l fresh water tank
- ✔ Super-S2 boom:
15, 16, 18, 20, 21, 24, 27 or 28 metres
- ✔ UG Special with a 250 l/min single pump
UG Super with 370 l/min dual pump



UG 2200 Special
21 m Super-S2 boom



Robust, stable and reliable

The wide, profile steel frame, compact tank and the robust boom technology all contribute to the required reliability. All the edges are rounded off and all hoses are neatly routed inside the frame.



Chassis of choice

The width adjustable axle can be specified unbraked or equipped with a dual-circuit compressed air, or hydraulic braking system, as required. The track width can be infinitely adjusted to between 1.50 and 2.25 m. 40 km/h type approval on request.

Soil structure and crop saving travel

Selection of the right tyres is of the utmost importance if the soil is to be protected during work.

AMAZONE mudguards can be adjusted for the various tyre options. The mudguard equipment option includes a large canister holder to the right hand side as standard.



For any linkage, the right drawbar

SelfTrail and UniTrail steering systems react directly to the steering action of the tractor. The following sprayer axle oversteers by a little when coming in into the turn. The tracking quality is completely independent from forward speed.



SelfTrail drawbar steering

A simple, sturdy drawbar is provided that gives continuous track following operation.

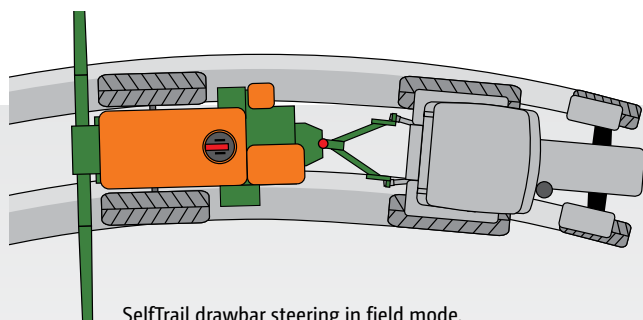

SelfTrail drawbar steering in field mode.



UniTrail drawbar steering

The UniTrail steering system can be quickly converted ready for road transport. In the transport position it is possible to drive safely at speeds of up to 40 km/h without a problem. Optionally, a hydraulic drawbar steering is available for when working across slopes.

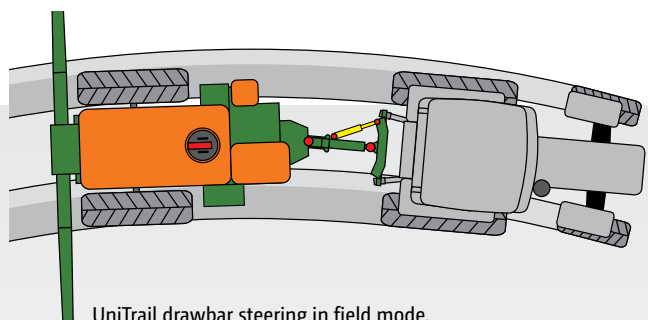

UniTrail drawbar steering in field mode.

Quick on the road – Excellent in the field!

AutoTrail steering systems are software-controlled and can be calibrated precisely to give near-perfect track following. In work, the steering system can either be manually overridden or switched off via the AmaPilot+ multi-function joystick.



Straight drawbar



Hitch drawbar

AutoTrail drawbar steering

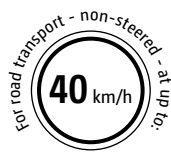

AutoTrail drawbar steering is available for both the straight drawbar and the hitch drawbar. A variety of towing eyes offer a solution to all tractor drawbar options.

As an alternative to the automatic slope correction adjustment with AutoTrail, there is on this drawbar also a manual hydraulic drawbar steering system for slope correction.

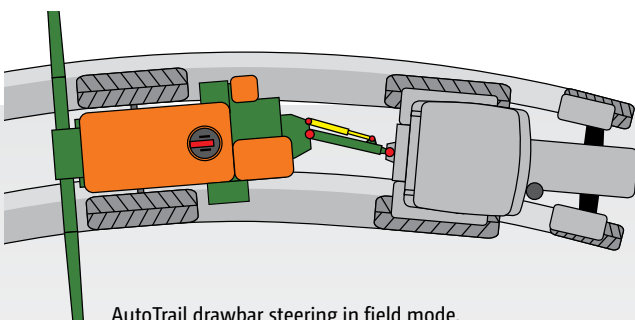

AutoTrail drawbar steering in field mode.

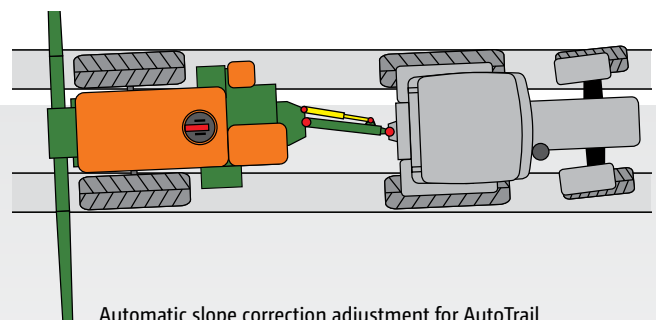

Automatic slope correction adjustment for AutoTrail

Proven technology for the most arduous of operations



- 1) Robust wide profile steel frame in which all hoses are routed so that they are protected.
- 2) Compact tank with smooth internal and external walls.
- 3) Induction bowl with Power-Injector for the induction of large quantities of chemicals and for canister flushing.
- 4) Large fresh water tank for diluting residual amounts or for cleaning the sprayer, even when the tank is full.
- 5) Separate hand wash tank (20 litres).
- 6) Mechanical direct fill level indicator with float and also electronically in the in-cab terminal as standard.
- 7) Clothing locker for agricultural protective clothing (optional).

✔ Clearly laid out operator station

All control elements are logically and unmistakably arranged directly to the front left-hand side of the sprayer. All the spraying functions can be quickly and intuitively understood thus preventing any operator errors.



The suction filter can be easily accessed via the simple AMAZONE bayonet coupling without the loss of spray liquid.



On AMAZONE sprayers, the flushing outflow from the self-cleaning pressure filter is used for agitation (switching via Pos. 1). The pump equipment on the UG Super is suitable for high agitation outputs at low PTO shaft speeds (switching via Pos. 2).

Piston diaphragm pumps

The piston diaphragm pumps are particularly reliable, protected when run dry and are safe for liquid fertiliser. The multiple-cylinder design of the pumps simultaneously ensures even delivery with a high suction power and smooth operation. The pumps are available with delivery capacities of 250 l/min (Special) or 370 l/min (Super). The 370 l/min pump setup is a tandem pump, where the spraying pump works together with a separate agitation pump. The tandem pump is ideal for farms using high application rates.



Hydraulic agitation intensity

The intensity of the hydraulic agitation can, steplessly, be reduced down to nothing in order to avoid any foaming of the crop protection agent or to facilitate spraying out the remaining tank contents.

On AMAZONE sprayers, the flushing outflow from the self-cleaning pressure filter is used for agitating (1). The pump equipment of the UG Super is suitable for high agitation outputs at low PTO shaft speeds (2).

Fill capacity 400 l/min

The sprayer can be filled with the help of a suction hose (3") with non-return valve or bowser fill connection with C-coupling. Utilising the additional injector that can be activated, means that filling rates of up to 400 l/minute can be achieved.



Filling via the suction hose



Filling using pressure (C or Camlok coupling)

AMAZONE application technology



 Play it safe with the AMAZONE induction bowl.



Fresh water tank with Vario control for flushing and diluting

The large fresh water tank always carries sufficient clean water for flushing and for diluting residual quantities. If the Vario control is set to the “flush” position, the suction filter, pump, valve chest, boom spray line and nozzles are cleaned with fresh water.

This is also possible when the spray liquid tank is full. This rules out the possibility of malfunctions caused by dried on spray liquid.

Inducting via the induction bowl and power injector

The induction bowl is able to quickly and reliably dissolve powdered agents and large quantities of urea through the incorporated rinse ring and, at the same time, to quickly flush them in with the power injector.

A rotary nozzle ensures that the spraying agent canisters are easily and conveniently cleaned to make full use of the contents. The closed induction bowl can be flushed for self-cleaning. The fill level indicator is always in view.

Internal and external cleaning

Two powerful rotating nozzles clean the internal walls of the tank.

As an option, the outside of the boom can be cleaned in the field with the external wash kit. The spray lance with its 10 bar working pressure ensures a good cleaning effect.



AmaSpray⁺ in-cab terminal

AmaSpray⁺ – simple and versatile

The AmaSpray⁺ enables simple yet fully automatic control of the UG. Switches integrated into the operator terminal enable the control of 5, 7 or 9 part-width sections. The AmaSpray⁺ has a digital pressure display and a digital tank level indicator. It records the quantity applied and area worked. The hydraulic functions are operated using the spool valves on the tractor. The boom tilt and pendulum lock are also displayed in the AmaSpray⁺. As an option, AmaSpray⁺ enables one-sided folding of the boom or, alternatively, control of the end nozzles.

The AmaSpray⁺ operator terminal with serial Interface can also be used for automatic documentation (ASD) and part-area, site-specific application.

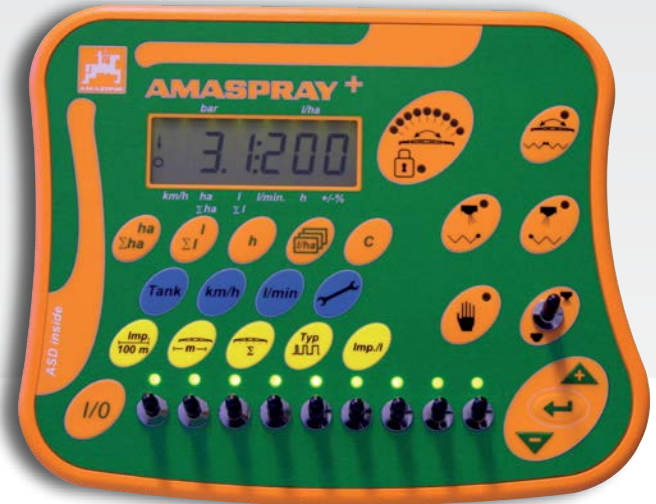

The benefits:

- ✔ Single, high-contrast, backlit screen
- ✔ Overall and part-width section control
- ✔ Up to 9 part-width sections
- ✔ Digital pressure indication
- ✔ Digital fill-level indicator
- ✔ Display of boom position and locking status
- ✔ Hectare meter (total and daily counter)
- ✔ +/- 10 % key
- ✔ Field record management system

Additional functions (with optional equipment):

- ✔ Pre-select fold for independent boom folding
- ✔ End or boundary nozzle on/off control (as an alternative to pre-select fold)
- ✔ Fold or tilt via 1 double acting spool valve (electric changeover switch)
- ✔ ASD inside: serial interface



Electrically-controlled TG valve chest

Cutting-edge valve technology is available for ISOBUS control and the AmaSpray⁺. The part-width boom sections are switched, on and off, quickly and drip-free via electric motor valves with pressure relief.

The amount applied is accurately and directly controlled by the computer in all situations. A unit with equal pressure compensation is not required with this system.

ProfiClick

The small switchbox
with a huge comfort factor



✓ ProfiClick mounts conveniently on the AmaSpray+

For boom control and steering

The ProfiClick switchbox offers the simple and precise actuation of all hydraulic functions of the booms and steering with AMAZONE crop protection sprayers.

It is available in combination with the electro-hydraulic "Profi-fold 1" for the entire range of AMAZONE crop protection sprayers. All the operational functions of the ProfiClick switchbox are ergonomically arranged and directly linked with that function. The potentiometer for the re-adjustment of boom tilt or for the automatic steering of a trailed sprayer can be controlled on the move without looking thanks to the detent position in the centre. So the driver can concentrate perfectly on driving.

The ProfiClick control box for operating the hydraulic functions of an AMAZONE sprayer can be combined with the AmaSpray+ machine terminal or any ISOBUS terminal. Thus it offers a cost-effective and comfortable control of the hydraulic functions via an oil circuit. On the tractor, only one single acting spool valve with a pressure-free return flow is required.

ProfiClick is available for UF, UG and UX without steering and the UG with drawbar steering or for a UX with axle steering.



✓ ProfiClick switchbox without steering
– Actuation of the boom functions via the oil circuit



✓ ProfiClick switchbox with steering
– Actuation of the boom functions and the steering for true track following via the oil circuit

- ① Ergonomic hand support
- ② On/off
- ③ Boom pendulum lock
- ④ Boom fold
- ⑤ Boom up/down
- ⑥ Boom tilt

- ① Ergonomic hand support
- ② On/off
- ③ Steering in automatic/manual
- ④ Manual steering
- ⑤ Boom pendulum lock
- ⑥ Boom fold
- ⑦ Boom up/down
- ⑧ Boom tilt

ISOBUS –

Machine actuation in the digital age

MEMBER OF



One language, many benefits!

Each ISOBUS-enabled machine from AMAZONE comes with the latest technology and almost unlimited possibilities. It does not matter whether you are using an AMAZONE terminal or an ISOBUS terminal directly installed in your tractor. ISOBUS is a worldwide recognised communication standard between, on the one hand, operator terminal, tractor and connected implements and, on the other hand, farm management systems.

Operation via any ISOBUS terminal

Which means that ISOBUS enables you to take control of all your ISOBUS compatible equipment. You just connect the machine with the relevant ISOBUS terminal and immediately the normal operator interface is displayed on the monitor screen in your tractor cab.

Benefits of ISOBUS:

- ✔ This worldwide standard provides a uniform interface and data exchange formats that ensure compatibility even with third party manufacturers
- ✔ Plug and Play between machine, tractor and additional ISOBUS implements



AMAZONE – More than just ISOBUS

Improved control, more yield! Precision Farming 4.0

Our competence in electronics

To increase the operational comfort, AMAZONE implements and operator terminals feature a scope of functionality way beyond ISOBUS standards.

The benefits of More than just ISOBUS:

- ✔ Highest compatibility and safety functionality of your ISOBUS equipment
- ✔ No additional modules on the machine side. All ISOBUS machinery from AMAZONE is already equipped as standard with the necessary ISOBUS functions
- ✔ MiniView display with all AMAZONE terminals and some further ISOBUS terminals. See, for instance, the machine data in the GPS view
- ✔ Possibility of operating the machine via the tractor terminal or a twin terminal solution
- ✔ Flexible assignment of the field and machine view between the tractor and the operator terminal
- ✔ Unique operation concept. Freely-configurable displays and individual user interfaces for each driver
- ✔ Freely-configurable machine operation as, for instance, the folding procedure for the booms on your AMAZONE crop protection sprayer
- ✔ Integrated TaskController data logger function



Automatic part-width section control GPS-Switch



If the terminal to be operated features Section Control, such as, for example, GPS-Switch part-width section control from AMAZONE, the switching of the part-width sections can be carried out completely automatically and in relation to the GPS position. Once a field has been established by the driver, then, in the automatic mode, they can fully concentrate on handling the vehicle whilst the switching of the part-width sections in wedges and on the headland is carried out automatically.

Benefits of automatic part-width section control:

- ✔ Stress relief on the driver
 - ✔ Increase in precision especially at night or at higher speeds
 - ✔ Less overlaps and gaps
 - ✔ Saving of resources
 - ✔ Less crop damage and environmental pollution
- ❗ “With Section Control, the ISOBUS computer relieves the driver from a lot of work.”
 (“dlz agrar magazine” – “Test report ZA-TS fertiliser spreader”. 02/2017)

GPS-Switch

With GPS-Switch, AMAZONE offers a GPS-based, fully automatic, part-width section control for all AMAZONE operator terminals and ISOBUS compatible fertiliser spreaders, crop protection sprayers or seed drills.

GPS-Switch basic

- ✔ Automatic part-width section control with up to 16 part-width sections
- ✔ Creation of a virtual headland
- ✔ Automated boom lowering for an AMAZONE sprayer
- ✔ Optional with AmaTron 4

GPS-Switch pro

- ✔ Automatic part-width section control of up to 128 part-width sections
- ✔ Marking obstructions (POI)
- ✔ Standard with AmaPad 2
- ✔ Optional with AmaTron 4

✔ **AmaClick**

Special crops and bed work often require the on/off switching of the individual part-width sections in the middle of the boom. AmaClick is an additional ergonomic control unit that can be used either in conjunction with the AmaPilot+ multi-function joystick or also as a standalone system alongside an ISOBUS terminal.



Workday made easy –

Make the most of the possibilities!

GPS-Maps&Doc

All standard ISOBUS terminals from AMAZONE can collect and save machine and site-specific data using Task Controller. Part-area, site-specific operation via the application maps in a shape and ISO-XML format is also possible.

- ✔ Easy creation, loading and processing of jobs
- ✔ Documentation and export of the work done in ISO-XML format
- ✔ Display of inactive field boundaries
- ✔ Automatic field recognition
- ✔ Job summary via PDF export
- ✔ Intuitive system for processing application maps
- ✔ Automatic part-area, site specific regulation of the application rate
- ✔ Optimum crop management using need-oriented application
- ✔ Standard on AmaTron 4 and AmaPad 2

GPS-Track

The GPS-Track parallel driving aid makes orientation in the field much easier, particularly on grassland or in areas without tramline tracks.

- ✔ The virtual light bar in the status bar
- ✔ Automatic tramline control via GPS for AMAZONE seed drills
- ✔ Various track modes such as A-B Line or contour travel
- ✔ Standard with AmaPad 2
- ✔ Optional with AmaTron 4

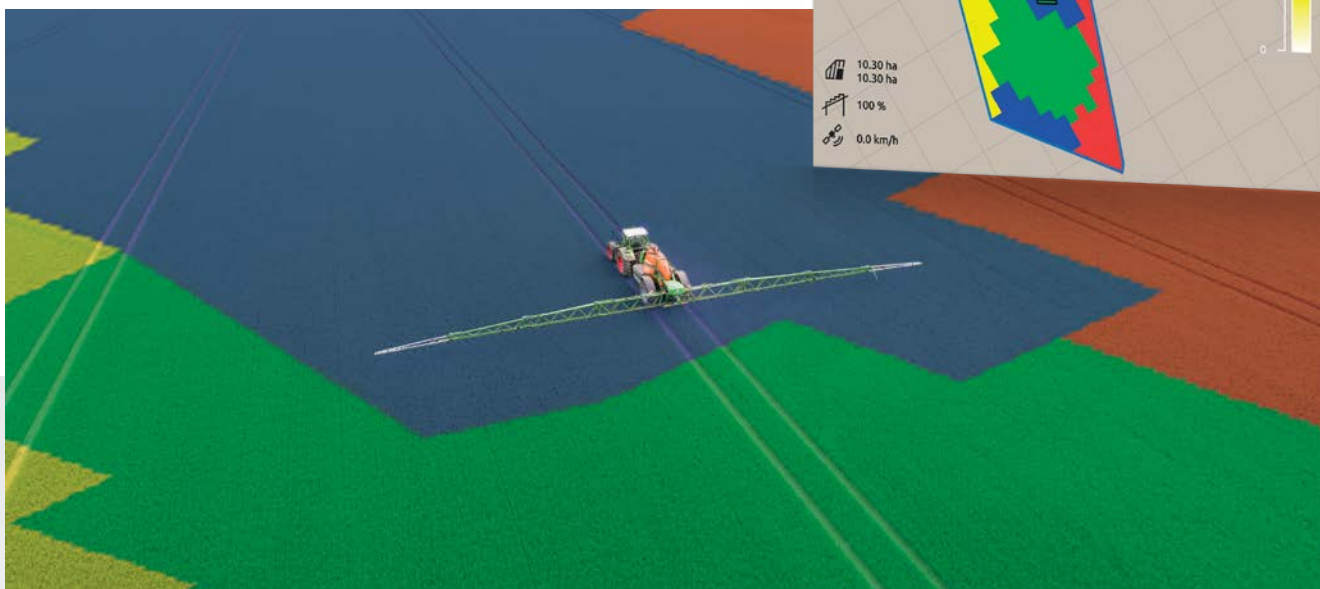

GPS-Maps – part-area, site specific application

AmaTron 4

Manager 4 all



Easy and comfortable operation as intuitive as your tablet

Why not handle a terminal as intuitively like a tablet or a smartphone? With this in mind, AMAZONE has developed the operator-friendly AmaTron 4 which offers a noticeably smoother operational process, especially when it comes to job management. The AmaTron 4, with its 8" multi-touch colour display meets the highest expectations and offers maximum user-friendliness. A swipe of the finger or using the App carousel allows quick changes between applications and the simple and clearly structured operating menu. A useful MiniView, a freely configurable status line as well as a virtual light bar make the use of the AmaTron 4 particularly clear and convenient.

- ✔ Machine operation (UT, Universal Terminal) in day-night mode

Benefits of AmaTron 4:

- ✔ Automated full image mode during non-operation
- ✔ Practical MiniView concept
- ✔ Operation via the touch display or via soft keys
- ✔ Especially intuitive and user-friendly
- ✔ Field-related documentation
- ✔ Practice-oriented and intelligent menu guidance
- ✔ Day-night mode
- ✔ Free test phase for all chargeable licences
- ✔ AmaTron Connect – for optional entry into the digital age

Standard with:

GPS-Maps&Doc



AmaTron Connect

Connected to your world

Communication in real time

With AmaTron Connect, AMAZONE provides a digital interface to a smartphone or tablet. The mobile device and the ISOBUS terminal AmaTron 4 are simply connected as a hotspot.

AmaTron Twin App – Clear display enhancement

The AmaTron Twin App offers the driver even more comfort in work, as GPS functions in the field view can also be operated via a mobile device (e.g. tablet) in parallel with machine operation in AmaTron 4.



- ✔ A better overview with the AmaTron Twin display enhancement

Advantages of the AmaTron Twin display enhancement:

- ✔ Use of an existing mobile device
- ✔ Greater clarity – all applications in sight
- ✔ Comfortable control of GPS functions in the field view in parallel via the mobile device



Map view with AmaTron Twin – Clear display of the machine and its part-width sections, as well as buttons on the right-hand side of the tablet display

agrirouter –

the independent data exchange platform for agriculture



Secure data exchange

AMAZONE opens the way to universal data exchange by means of the manufacturer-independent agrirouter. The agrirouter enables data to be exchanged between AMAZONE machinery, agricultural software, manufacturers and companies both securely and without any complications.

Advantages of agrirouter:

- ✔ Simple and easy handling
- ✔ Comfortable and fast transfer
- ✔ Full control of your data
- ✔ Data is transferred, not stored
- ✔ Manufacturer-independent use

myAmaRouter App – comfortable and simple

The myAmaRouter App enables data to be exchanged between the AmaTron 4 ISOBUS terminal and the agrirouter manufacturer-independent data exchange platform. If an AMAZONE machine is to be used to carry out a task with job data (e.g. application maps), the data can be easily transmitted from the agrirouter to the AmaTron 4 via the myAmaRouter App and sent back after completion.

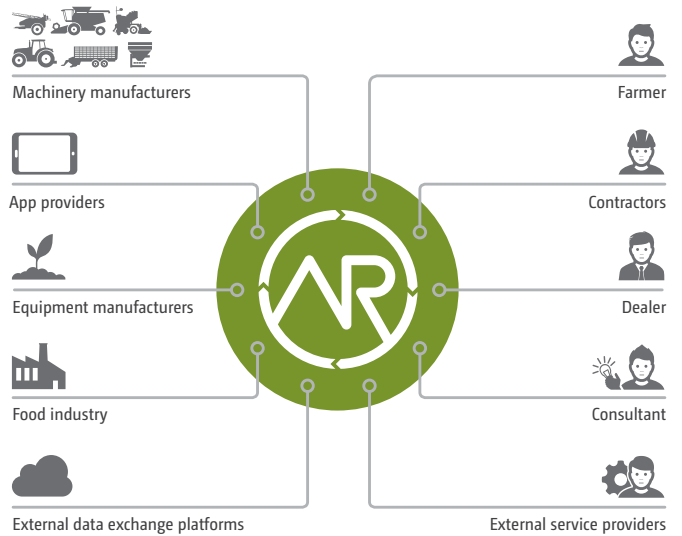

- ✔ The manufacturer-independent agrirouter enables secure and uncomplicated data exchange

Uncomplicated data transfer. Transparent and secure!



AmaPad 2

The especially comfortable way to control agricultural machinery



The new dimension of control and monitoring

AmaPad 2 from AMAZONE is a particularly high-quality operator terminal. The 12.1" multi-touch colour display is particularly comfortable and fulfils the highest demands of Precision Farming. AmaPad 2 is operated solely via touch.

With the practical "MiniView concept", applications which aren't being actively operated at that moment but need to be monitored are clearly displayed at the side. When needed these can be enlarged via "a finger swipe". The possibility to individualise a "dashboard panel" with the displays of choice rounds up the user ergonomics.

Benefits of AmaPad 2:

- ✔ Large 12.1" multi-touch colour display
- ✔ Extended MiniView concept
- ✔ Integrated light bar
- ✔ 2 camera connections
- ✔ Day-night mode

Equipped as standard with:

GPS-Maps&Doc
GPS-Switch pro
GPS-Track



AmaPilot⁺ – Everythingsource comes to hand!

Thanks to the AUX-N feature, you can operate multiple functions of the machine via AmaPilot⁺ or any other ISO-BUS multi-function joystick.

The benefits of AmaPilot⁺:

- ✔ Almost every function directly controlled over 3 levels
- ✔ Adjustable palm rest
- ✔ Freely-programmable, individual key layout







ISOBUS terminals from Amazone – Intuitive, comfortable, better

The benefits:

- ✔ Uniform AMAZONE operating philosophy
- ✔ Practical-oriented and logical menu structure
- ✔ Simple and clear operation
- ✔ Freely configurable user interfaces

Terminal	AmaTron 4 	AmaPad 2 
Display	8 inch, multi-touch colour display	12.1 inch, multi-touch-colour display
Mode of operation	Touch and 12 soft keys	Touch
Interfaces	Serial interface for GPS 2x USB ports	
Sensor connection (e.g. nitrogen sensor)	via SCU-L adapter	via SCU-L adapter or PeerControl
Job management and processing of application maps (ISO-XML and shape)	GPS-Maps&Doc	
Automatic part-width section control (SectionControl**)	GPS-Switch basic * with up to 16 part-width sections or GPS-Switch pro * with up to 128 part width sections	GPS-Switch pro with up to 128 part width sections
Parallel driving aid	GPS-Track * with virtual light bar	GPS-Track with virtual light bar
Automatic track following	–	GPS-Track Auto * for the Pantera self-propelled crop protection sprayer
Camera connectivity	1 x camera connection * with AmaCam automatic reversing detection	2 x camera connections *

* = optional / ** = Note the max. no. of machine part-width sections

Comfort-Pack for ISOBUS terminals

Operator- and environmentally-friendly



Comfort-Pack



Control of the spray liquid system

The AMAZONE Comfort-Pack controls the most important functions of the liquid system.

- ✔ Automatic fill stop
- ✔ Agitator regulation
- ✔ Automatic, in-cab remote cleaning

The intensity of the hydraulic agitator is, depending on the fill level, reduced until completely shut off to prevent foaming of the crop protection agent or to minimise the residual spray volumes. On AMAZONE crop protection sprayers the un-sprayed plant protection agent is delivered back via the return flow into the suction system. In this way, any unintended dilution of the spray liquid is prevented. 370 l/min

agitation capacity is available to achieve a perfect result even with difficult tank mixes and high concentrations. The 2 interior cleaning nozzles provide an optimum cleaning performance in the tank. The Comfort-Pack automatically ensures that the agitation will be rinsed.

Minute final residual volumes of less than 6 litres and the large fresh water contents ensure a very effective cleaning procedure whilst still in the field.

AMAZONE aircraft-style boom design

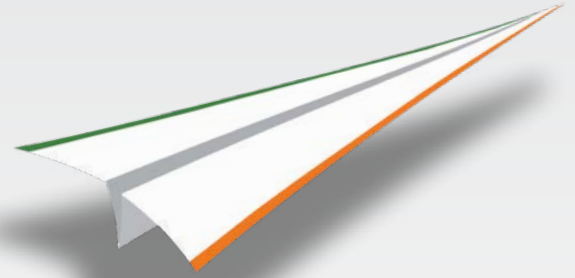

Simultaneously superbly strong and superbly light

Due to the special profile design AMAZONE sprayer booms are very light yet at the same time very robust. Working widths of 15 to 28 metres allow optimum adaptation to the field sizes and topography on the farm with various folding options. The exceptionally high-quality ensures a long operational life even over very high acreages.



Superbly narrow transport width of only 2.40 m

The Super-S2 boom folds fully automatically in and out via hydraulic rams. In the transport position, the boom sits compactly behind the tank with a transport width of only

2.40 m and a transport height of 3.30 m. With steel profiles up to 140 mm wide with multiple bends, the Super-S2 boom is extremely strong.



Super-S2 boom: firm and steady



3-fold shock damping suspension for the most difficult operating conditions

As standard all AMAZONE booms are equipped with

- ✔ springs and shock absorber pack for damping the vertical roll movements,
- ✔ rubber buffer damping elements with ball suspension to damp down the horizontal yaw movements and
- ✔ tension springs for the shock absorbed suspension of the entire boom.

As standard also is hydraulic height adjustment with guide skids that results in the perfect boom guidance and thus, the accurate longitudinal and lateral distribution of the spray liquid.

Super-S2 boom suspension

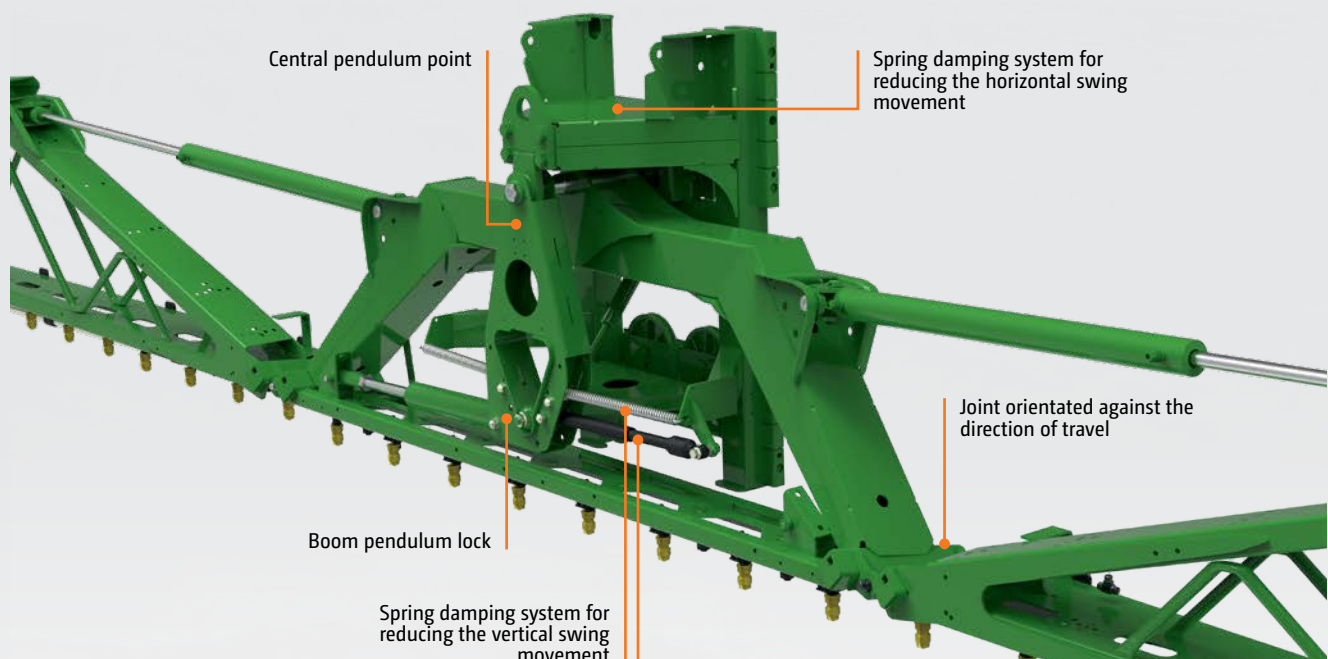



1 Practical experience with the Super-S2 boom

“We are delighted with the performance of our record-breaking sprayer:

The joints and the entire boom system have not suffered from any fatigue even well after 100,000 hectares of spraying.”

Carin Handriek, Landwirtschaftliches Zentrum Hörstetal e.G., 99880 Mechterstädt

Maintenance-free and with a long service life

The decades of experience in boom design pay off: The conical hinge pin is the intelligent centre of a well thought-out boom philosophy! The boom pivots self-adjust against any play on the conical hinge pins and that ensures, for the end user, an optimised boom function even after many years.

The standard use of stainless steel, the automotive-industry standard, cathodic dip painting process and the targeted use of plastics and aluminium are the perfect guarantee of a long service life.

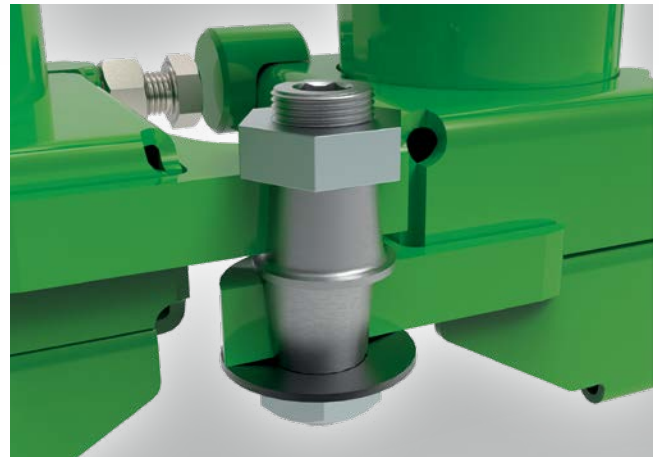

✔ A pivot joint that lasts!

Boom layout and folding variants of the Super-S2 boom

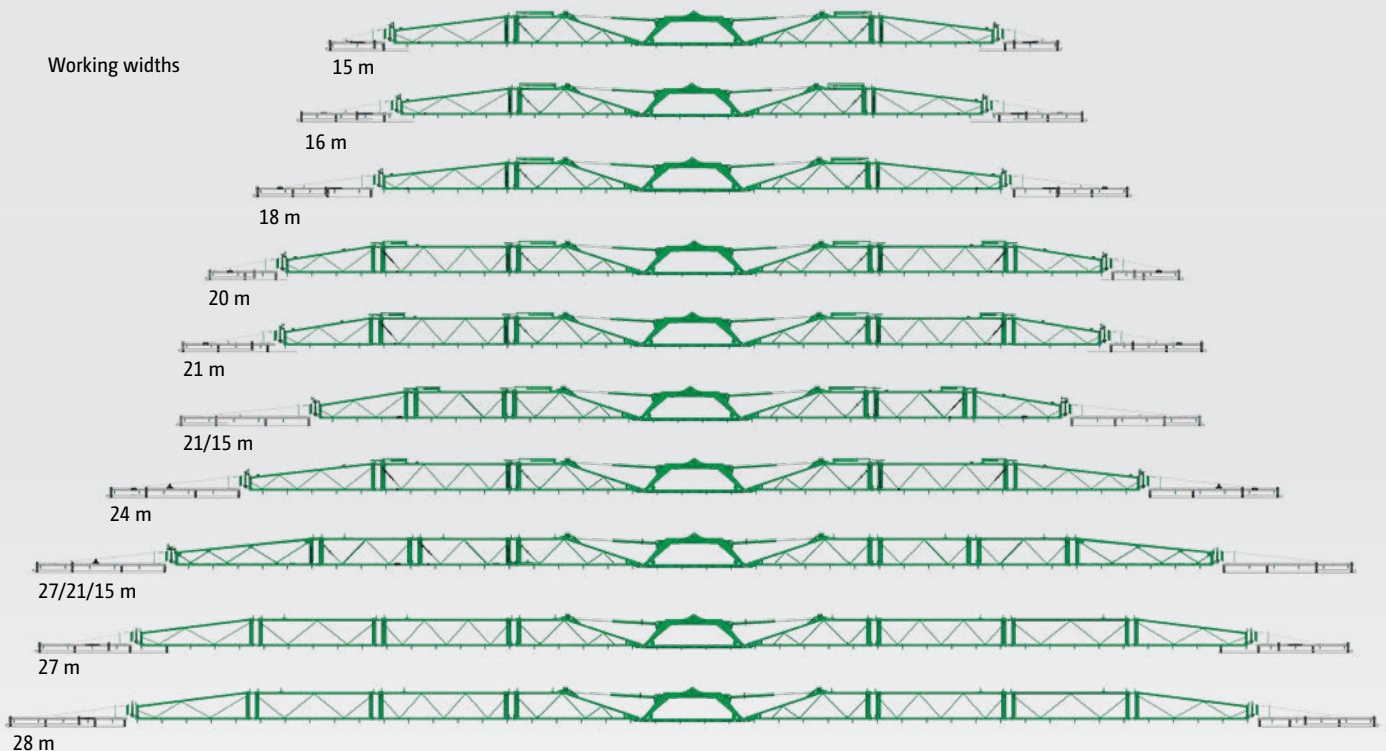

Flexibility thanks to the hydraulic boom folding permutations



✔ Standard folding

All boom options are folded fully hydraulically by oversized hydraulic cylinders.

✔ Hydraulic tilt adjustment

On sloping terrain and with large working widths, the additional hydraulic tilt adjustment with its in-cab tilt display is useful.

Pre-select folding

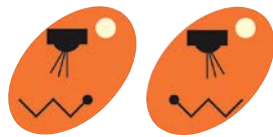

One-side folding via tractor spool valves is possible with the AmaSpray⁺ or an ISOBUS terminal.

The high level of flexibility offered by the pre-select folding function enables all boom sections to be folded individually. Both the left and right-hand sides can be folded in sepa-



ately and independently of each other in order to adapt to any circumstances in your fields.

Profi-fold

Profi-fold refers to the electro-hydraulic actuation of the boom via an oil circuit. Height adjustment, folding in and out, independent folding, boom width reduction and tilt adjustment functions (Profi-fold 1) can be

easily controlled via the ISOBUS terminal or the multi-function joystick. Additional boom tip angling is possible with Profi-fold 2.

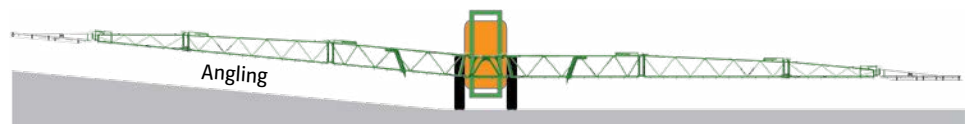

Profi-fold 2

DistanceControl with 2 sensors or DistanceControl plus with 4 sensors

The DistanceControl fully automated boom guidance system with 2 sensors, or DistanceControl plus with 4 sensors, is possible on all boom variants in conjunction with Profi-fold 1 or Profi-fold 2. In heavily differing crop heights, or in areas with partially lodged corn, it could be that the boom, when equipped with 2 sensors, dips into the crop. In this

case, equipping the boom with four sensors will prevent this. The sensors are electrically connected in parallel and so it is always the sensor that is closest to the target surface that is actuated.

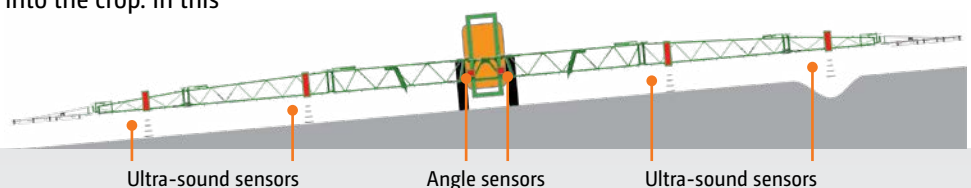

The right nozzle choice

The basis for success in crop protection



Less drift also at higher wind speeds

With the air-assisted injector nozzles, crop protection agents can be applied with very little drift. They are universally usable in all crops and all classifications. Because of the coarse droplet application, these nozzles can also be used in higher wind speeds.

AMAZONE offers a wide range of nozzles from agrotop, Lechler and TeeJet.

Single and multi-nozzle bodies

The nozzle bodies with integrated diaphragm non-return anti-drip valves fit up into the boom profiles reliably preventing any dripping at the nozzle. Self-adjusting bayonet fixings ensure a tool-less quick nozzle change. The 3-fold or 4-fold nozzle bodies are suited to frequent nozzle changes due to different applications and crops. Nozzle protection tubes, as standard on the outer sections, or, if desired, over the entire boom working width, ensures protection for long injector nozzles and multiple nozzle bodies.





Examples

- 1) Lechler IDN 120-025
- 2) TeeJet XRC 110-025
- 3) Injector flat fan nozzle AirMix 110-04



Everyone purchasing an AMAZONE crop protection sprayer receives, free of charge, an AMAZONE nozzle mounting tool that enables a much easier nozzle change.

Injector nozzles (ID, TTI) have a relatively coarse droplet spectrum and are particularly versatile with regard to their field of application. A pressure range of 2 to 8 bar is possible.

The split spray pattern ensures a more even deposit on the front and back of the plant and makes sense maybe, for example, in ear treatment.

If coverage quality is at the foreground of the application, the use of standard or anti-drift fine droplet nozzles, such as XR or AD, is recommended. Special care is required here due to their tendency to drift above 3 bar.

For speeds greater than 10 km/h, the TD HiSpeed nozzle with its asymmetrical spraying angle is becoming a new industry trend.

A good compromise is provided by the modern ID-K or Airmix compact injector nozzles. These have relatively little drift, but do not have too coarse a droplet spectrum and are operated at 2 to 4 bar.

Distribution of the droplet size

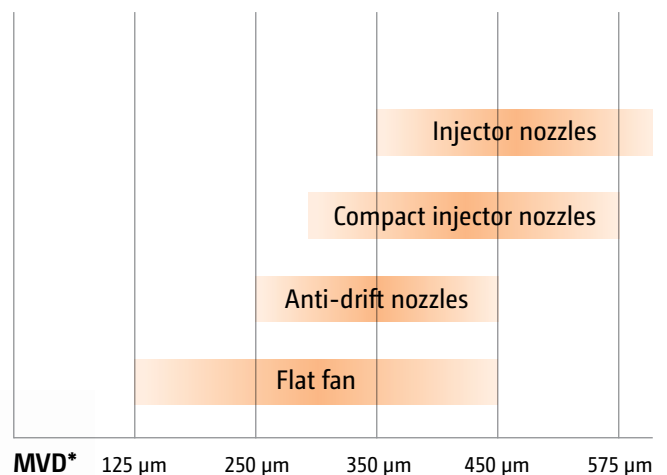

When it comes to special coverage qualities, the double flat fan nozzle is an interesting alternative: the AVI Twin from Agrotop also produces droplets that are not too fine.

MVD* 125 µm 250 µm 350 µm 450 µm 575 µm
 very fine droplet fine droplet medium droplet extremely coarse droplet coarse droplet very coarse droplet

* mean volumetric diameter



DUS pressure recirculation system

With DUS you determine the timing

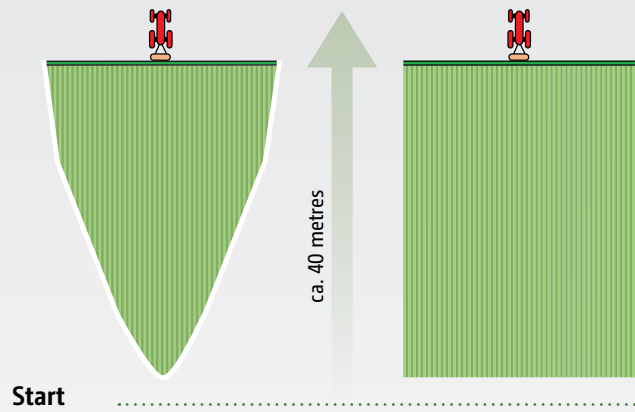

without DUS

with DUS Immediate coverage over the full working width

The DUS pressure recirculation system – proven more than 10,000 times

The AMAZONE DUS pressure recirculation system ensures a reliable circulation throughout the entire system. When starting the spraying operation, all the hoses including the spray lines are filled under pressure in the reverse direction with the mixed spray agent. This means the spray lines are always full and immediately ready to use over the entire working width. There is no waiting on the headland.

Every time individual part-width sections are shut off, during the turning operation and during transport, the spray liquid circulates continually thanks to the pressure recirculation system. This reliably prevents deposits, blockages or segregation in the spray lines.

During the cleaning operation, fresh water flushes the spray lines out right up to the nozzles without any spraying being necessary. During this cleaning procedure, the concentrated spray liquid is returned back to tank via the pressure recirculation system leaving the spray lines clean.

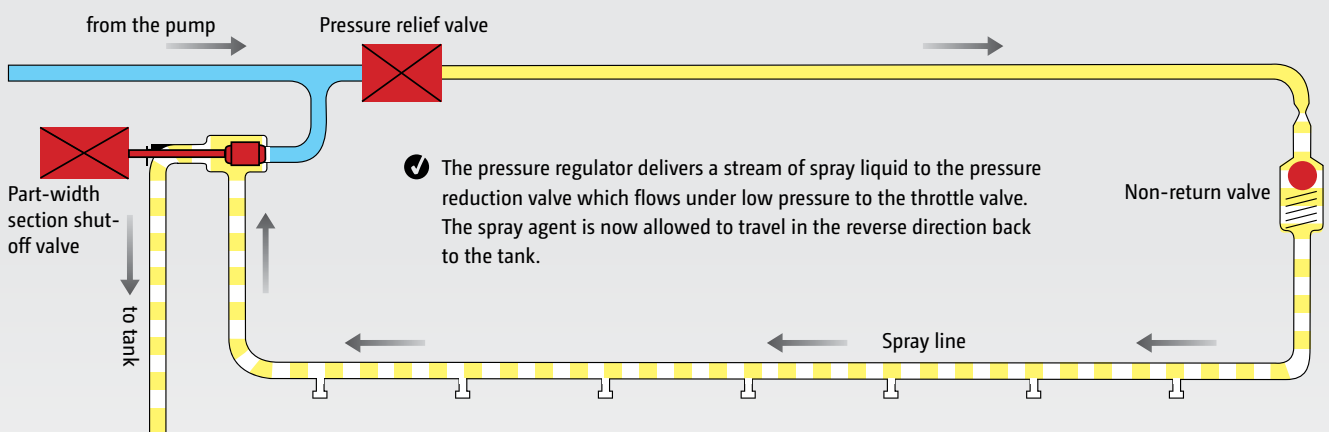

Electric boundary nozzle switching

For environmentally-friendly spray application at the field edge

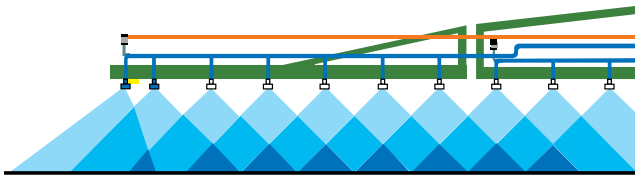

Additional nozzle switching

In order to extend the normal working width, an asymmetrical nozzle can also be switched on. This is particularly useful if the distances between tramlines are not precise enough.

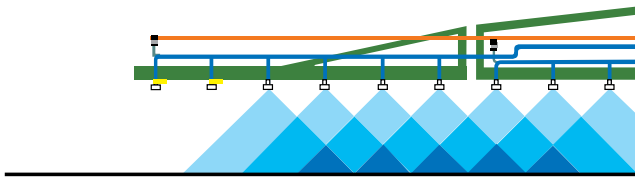

End nozzle switching

If a one metre buffer zone around the edge of the field needs to remain unsprayed due to distance constraints, end nozzle switching can be used.

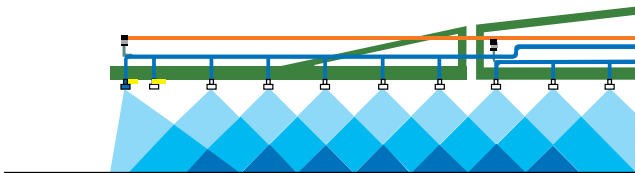

Boundary nozzle switching

For precision border spraying between two sensitive crops, the boundary nozzles can be used to make sure the spray pattern is accurately defined.



Equipment for every requirement



Drag hose with articulated joint

Liquid fertilising – Safe and user-friendly

For coarse droplet distribution of liquid fertiliser, AMAZONE offers a variety of special nozzles.

In conjunction with the Super-S2 boom, separate drag hose equipment for risk-free, late fertilising is available. The self-contained aluminium profiles can be attached with a few hand clamps. Drag hoses offer a risk-free late top dressing with liquid fertiliser and stainless steel weights help keep the position of the drag hoses within the crop.



7-hole nozzle



Camera system to the rear of the UG trailed sprayer

The optionally available camera system mainly serves for safety when manoeuvring. This is ensured even in rain, twilight or in darkness via infrared LEDs and a heated lens. The high resolution, antiglare monitor is backlit and can also display two cameras at once.



LED boom lighting for Super-S2 booms

For flexible and efficient operation at twilight and in the dark, LED boom lighting is available.

Two far-reaching LED work lights, mounted in the middle of the boom, ensure excellent visibility of all the nozzles at a glance.

LED individual nozzle lighting for Super-S2 booms

Professional work lighting is today the basis of a flexible, output-increasing solution to operating in twilight and at night. Illumination of the spray fans ensures complete control of the nozzle function at just one glance.

LED individual nozzle lighting picks out each individual spray fan. An absolutely immediate assessment of their operation down to the very last nozzle on the boom can be made.



AMAZONE – always in your vicinity

Your satisfaction is our challenge



AMAZONE SmartService 4.0

Due to the increasing use of evermore complex machine technology, AMAZONE utilises, with the SmartService 4.0, both virtual and augmented reality as well as digital media for service, training and maintenance advice.

- 1 SmartTraining:** Training and instruction in the use of complex machinery by using the Virtual Reality technology (VR).
- 2 SmartLearning:** Interactive driver's training for the user for complex machinery operation (www.amazone.de).
- 3 SmartInstruction:** Repair or maintenance instructions using Augmented Reality (AR) and via a mobile device.
- 4 SmartSupport:** Direct on-hand support from the service technician via Augmented Reality (AR) and via a mobile device.



The satisfaction of our customers is the most important objective

We rely on our nationwide network of expert, committed sales partners to achieve this. They are also the reliable contact for farmers and contractors when it comes to service matters. Continuous training ensures that our sales partners and service technicians are always up to date with the latest technology.

Better to choose the original right from the start

Your machines are subjected to extreme use! The quality of AMAZONE spare parts and wearing metal parts offers you the reliability and security you need for efficient soil tillage, precise sowing, professional fertilisation and successful crop protection.

Only original spare parts and wearing metal parts provide the durability and functionality expected from AMAZONE machinery. This guarantees an optimum work result. Original parts at fair prices pay for themselves in the end.

So opt for the original!

The advantages of original spare parts and wearing metal parts

- ✔ Quality and reliability
- ✔ Innovation and efficiency
- ✔ Immediate availability
- ✔ Higher resale value of the used machine

We provide you with a first class spare parts service

The spare parts warehouse in Tecklenburg-Leeden is the basis for our worldwide spare parts logistics system. This ensures optimum availability of spare parts, even for older machines.

Orders for parts in stock at the Tecklenburg-Leeden spare parts centre which are placed by 5 p.m. leave our premises the same day. 40,000 different spare parts and wearing metal parts are handled and stored via our modern warehousing system. Up to 800 orders are sent out to customers every day.

SmartLearning – The new way of driver training via a PC

AMAZONE has enhanced the service offering on its homepage with the "SmartLearning" Internet tool, a very useful function which can be found at www.amazone.de/smartlearning. "SmartLearning" is an interactive driver training programme which allows you to practice operating complex machinery both online and offline on a PC or tablet PC. The new service offer gives drivers the opportunity to familiarise themselves with the operation of a new machine before it is used for the first time. However, experienced drivers can also refresh their knowledge here, in order to make even better use of the performance potential of the machines.

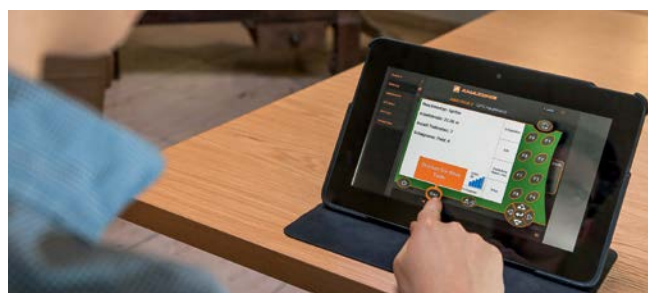



Technical data: UG Special and UG Super

Model	UG 2200 Special	UG 2200 Super	UG 3000 Special	UG 3000 Super
Actual volume (l)	2,400		3,200	
Fresh water rinse tank (l)	280		400	
Working width (m)	15 – 28			
Transport height (m)	3.30			
Transport length (m)	5.20 – 5.90			
Transport width (m)	2.40			
Empty weight with Super-S2 boom (kg)	2,350 – 2,582	2,461 – 2,693	2,573 – 2,805	2,685 – 2,917
Pump equipment (l/min)	250	370	250	370
Max. suction capacity (l/min)	400			
Ground clearance	for every drawbar and tyre size 0.70 – 0.90 m			
Spraying height	0.50 – 2.20 m (with tyres \varnothing 1,565 mm)			
Operating pressure, max. (bar)	< 10			

Illustrations, content and technical data are not binding! Deviations of technical data are possible depending on the equipment. The illustrations may deviate from the requirements for local road traffic regulations.



AMAZONEN-WERKE H. DREYER SE & Co. KG
P. O. Box 51 · 49202 Hasbergen-Gaste/Germany
Phone +49 (0)5405 501-0 · Fax +49 (0)5405 501-193